

# 329CHPB

329 - 2000 W TUNGSTEN



- **Type:** Single lens luminaire
- **Source:** 2000 W Tungsten
- **Optics:** 200 mm Pebble lens
- **Standard:** North american

Single lens

## The industry standard for 2K units

329H is a favourite in theatres, opera houses and concert halls the world over.

A G22 lamp socket holds the lamp securely in place giving increased reliability and longer lamp life. Ideal for medium to large venues and rental companies.

### Features

- **Theatre front cassette:** no light spill to distract audiences or performers
- **Colour runners:** double runners to hold accessories and colour filters
- **Barn door:** unique rotating barn door with 4 individually rotating blades – makes even the most difficult angle possible
- **Focus adjustment:** smooth focus adjustment from front or rear, even when lantern is hot, for a longer lamp life
- **Tilt reference on hanging yoke:** index for rapid re-positioning

### Optical

- **200 mm lens:** compact size 2 / 2.5 KW fixture

### Construction

- **Made in France :** fully manufactured in Robert Juliat premises retaining complete control over all aspects of quality
- **Air vents:** efficient cooling with no light spill
- **Bodywork:** strong sheet metal construction for durability
- **Moving parts:** smooth at all times, even when hot
- **Captive knobs and handles:** additional security when working at height or in transit
- **Access:** easy access to lamp house and lenses through front opening for fast and efficient maintenance
- **Easy access to all parts:** easy cleaning, re-lamping and maintenance
- **Safety grid:** earthed safety grid fitted as standard
- **Safety first:** front accessories safety cable attachment point

Picture:329H

DSEN021\_329CHPB - 23/03/2022

Robert Juliat reserves the right to change or alter any of the items detailed on this page, to increase or improve manufacturing techniques without prior notice.

Robert Juliat S.A.S., 32 rue de Beaumont, 60530 Fresnoy-en-Thelle - France  
Telephone : +33 (0)3 44 26 51 89 - fax : +33 (0)3 44 26 90 79 - info@robertjuliat.fr  
www.robertjuliat.com



ROBERT JULIAT

## Source



- **Lamp type:** Tungsten
- **Socket:** G22

Admissible lamps	Power *	Lumen output*	Colour temperature*	Life*
LIF: CP92 - 120V - ANSI: CP92 -	2 000 W	55 000 lm	3200K	400 h

(\*) manufacturer's data

## Optics

### Characteristics

- **Type:** Single lens
- **Beam range:** 9° to 68°
- **Lens:** 200 mm Pebble lens

### Gel filter

- **Shape:** Square
- **Standard size:** 245x245 mm (9.6x9.6 in)

## Photometrics

with LIF: CP92 source

### • Optics @ 17°

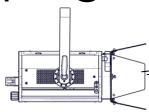

17°

Field angle  
3%

Beam intensity  
150 000 cd

<b>Distance</b>	5 m	10 m	15 m	20 m	25 m	30 m
<b>Diameter</b>	1.5 m	3 m	4.5 m	6 m	7.5 m	9 m
<b>Illumination</b>	6 100 lux	1 550 lux	670 lux	380 lux	250 lux	170 lux
<b>Distance</b>	15 ft	35 ft	50 ft	65 ft	80 ft	100 ft
<b>Diameter</b>	4.5 ft	10.5 ft	14.9 ft	19.4 ft	23.9 ft	29.9 ft
<b>Illumination</b>	670 fc	130 fc	65 fc	36 fc	24 fc	16 fc

## Dimensions and weight

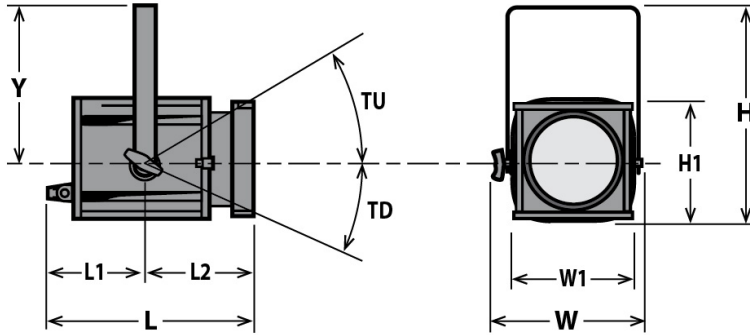

**Weight:** 14 kg (30.8 lbs)

Height	Length	Width	Yoke	Tilt
H= 520 mm (20.5 in) H1= 320 mm (12.6 in)	L= 470 mm (18.5 in) L1= 285 mm (11.2 in) L2= 185 mm (7.3 in)	W= 410 mm (16.1 in) W1= 320 mm (12.6 in)	Y= 345 mm (13.6 in)	TU= TBD° TD= TBD°

## Shipping

- **Weight :** 16 kg (35.2 lbs)
- **Volume :** .09 m<sup>3</sup> (3.18 ft<sup>3</sup>)

## Installation

- **Minimum distance to illuminated surface:** 2.7 m ( 8.9 ft )
- **Operating position:**



## Warranty

- **Fixture: 2 years**  
See General Sales Condition on website

## Approvals



## Construction

- **Housing:** Steel sheet - Aluminium
- **Colour:** Black
- **Cooling:** Convection cooling
- **Maximum ambient temperature (Ta):** 40°C (104°F)
- **Maximum case temperature (Tc):** 250°C (482°F)
- **Total heat dissipation:** 6 826 BTU/h
- **Ingress Protection (IP) rating:** IP20

## Electrical compatibility

- 230/240 V - 50 Hz
- 115/120 V - 60 Hz

## Power input



- **Type:** attached power cord
- **Cable:** 12 AWG SJ type (UL/CSA)
- **Length:** 1.5 m (4.9 ft)
- **Power connector:** without connector

## Power consumption

Voltage	Frequency	Current	Power
120 V	60 Hz	17 A	2000 W







## Model

**329CHPB**

2000 W Tungsten Single lens luminaire - G22 socket - 200mm Pebble - 329CHPB - North american standard

## Options

## Accessories

<b>PF329M</b>	245x245mm metal filter holder - Poids: 0.23 Kg <b>1 included</b>	
<b>G329</b>	245x245mm safety grid <b>1 included</b>	
<b>CF329</b>	4 rotating leaves on a rotating barndoor - 245x245mm (without safety cable) - Poids: 1.42 Kg	
<b>876</b>	Hook clamp 40x10mm with 28mm M10 screw for Ø35 to 50mm pipes - SWL: 50Kg - Poids: 1.25 Kg	
<b>880</b>	Hook clamp 40x10mm with 28mm M10 screw for Ø50 to 63mm pipes - SWL: 50Kg - Poids: 1.36 Kg	
<b>CS2</b>	Safety cable Ø3 mm L= 600mm - SWL: 75 Kg	
<b>CS5</b>	Safety cable Ø1,5 mm L=300mm for front accessory with karabiner and quick link - SWL: 25 Kg	