

# D'ARTAGNAN - 930CSNX

900SNX - 2500 W HID



- **Type:** Profile spot
- **Source:** 2500 W HID
- **PSU:** Magnetic - hot restrike - DMX
- **Optics:** 10° to 25° zoom
- **DMX-control of motorised dimmer shutter and lamp ignition**
- **Standard:** 208 V North american

Profile spot

## The one to call on when you need power!

The 2500 W D'Artagnan is the most powerful of profiles: indispensable for dramatics effects at the opera, ideal for outdoor TV recordings, fashion shows and large trade fair stands. It is the benchmark among profile spots for all large scale shows and can be seen in spectaculars across the world.

### Features

- **Multi-function double gate:** simultaneous use of gobos and iris. Sharp focus of both gobo and shutter
- **Shutter gate:** up to 8 shutters. Remove shutters for easy maintenance or tuck fully inside gate for secure transport
- **User-friendly shutter-lock system:** secures shutters' setting in any circumstances (locking efficient up to 4 shutters)
- **Universal gobo holder:** "A" size glass and metal gobo
- **Gate lock feature:** secures rotating gate against unwanted movement
- **90° rotating gate :** rotation of the projected image is always possible while the lamp remains vertical – no need to move the yoke
- **Built-in motorised dimmer shutter:** perfect and smooth dimming control from 0 to 100% by DMX
- **Internal glass filter holder:** long term use of durable coloured, dichroic or textured glass
- **DMX remote controlled ignition**
- **Easy focus reference:** graduated scale on side of the unit; fast and easy refocusing
- **Tilt reference on hanging yoke:** index for rapid re-positioning

### Optical

- **Factory set optical train:** no re-alignment even after lamp change
- **SX optical system:** double condenser optics for exceptional optical quality
- **Gobo :** excellent gobo projection
- **Variable zoom optics:** sharp focus at every beam angle. Independent control of image size and focus. Focus handles on both sides

### Construction

- **Made in France :** fully manufactured in Robert Juliat premises retaining complete control over all aspects of quality
- **Separate PSU:** compact for easy handling and rapid maintenance
- **Silent-running cooling fans:** ideal for TV studios and opera houses
- **Bodywork:** strong sheet metal construction for durability
- **Moving parts:** smooth at all times, even when hot
- **Captive knobs and handles:** additional security when working at height or in transit
- **Easy access to all parts:** easy cleaning, re-lamping and maintenance
- **Removable assemblies:** fast-plug cable connectors and complete component assemblies (mirror, condenser set and lamp house assembly) save maintenance and cleaning time
- **Spare parts and accessories:** interchangeable across the tungsten, discharge or LED ranges, reducing running costs

Picture:930SNX

DSEN078\_930CSNX - 23/03/2022

Robert Juliat reserves the right to change or alter any of the items detailed on this page, to increase or improve manufacturing techniques without prior notice.

Robert Juliat S.A.S., 32 rue de Beaumont, 60530 Fresnoy-en-Thelle - France  
Telephone : +33 (0)3 44 26 51 89 - fax : +33 (0)3 44 26 90 79 - info@robertjuliat.fr  
www.robertjuliat.com



ROBERT JULIAT

## Source



- **Lamp type:** Discharge
- **Power:** 2500 W
- **Socket:** G38
- **Hot re-strike:** yes

Admissible lamps	Power *	Lumen output*	Colour temperature*	Life*	CRI* (min)
CSR 2500W SEHR (GE)	2 500 W	220 000 lm	6000K	500 h	90
HMI 2500W/SE XS (Osram)	2 500 W	240 000 lm	6000K	500 h	90
MSR 2500W HR (Philips)	2 500 W	240 000 lm	6000K	500 h	95
USR 2500W HR (Ushio)	2 500 W	240 000 lm	5600K	500 h	80

(\*) manufacturer's data

## Optics

### Characteristics

- **Type:** Zoom
- **Beam range:** 10° to 25°
- **Focal length:** 180 - 457 mm

### Gel filter

- **Shape:** Square
- **Standard size:** 254x254 mm (10x10 in)

### Gobo

- **Size:** A
- **Material:** Metal  
Glass

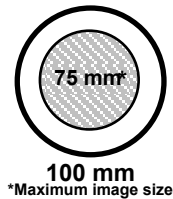

## Photometrics

with MSR 2500W HR (Philips) source

### • Optics @ 10°

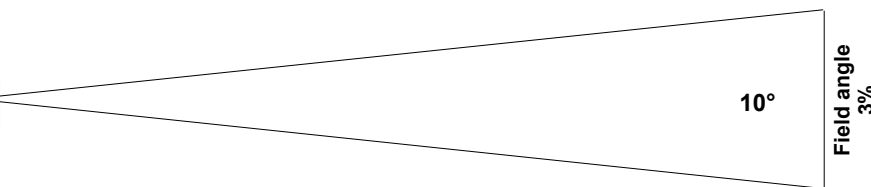
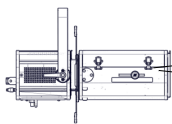

**Beam intensity**  
1 668 000 cd

<b>Distance</b>	20 m	30 m	40 m	50 m	60 m	70 m
<b>Diameter</b>	3.5 m	5.2 m	7 m	8.7 m	10.5 m	12.2 m
<b>Illumination</b>	4 200 lux	1 900 lux	1 050 lux	670 lux	470 lux	350 lux
<b>Distance</b>	65 ft	100 ft	130 ft	165 ft	195 ft	230 ft
<b>Diameter</b>	11.4 ft	17.5 ft	22.7 ft	28.9 ft	34.1 ft	40.2 ft
<b>Illumination</b>	400 fc	170 fc	100 fc	65 fc	44 fc	32 fc

### • Optics @ 25°

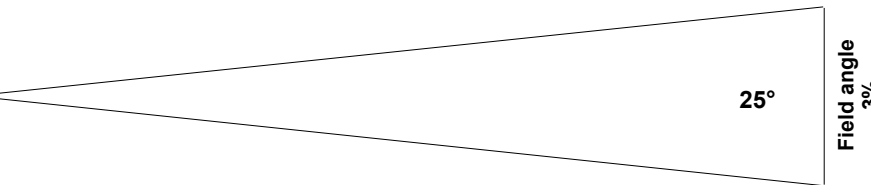
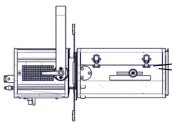

**Beam intensity**  
194 000 cd

<b>Distance</b>	20 m	30 m	40 m	50 m	60 m	70 m
<b>Diameter</b>	8.9 m	13.3 m	17.7 m	22.2 m	26.6 m	31 m
<b>Illumination</b>	490 lux	220 lux	130 lux	80 lux	55 lux	40 lux
<b>Distance</b>	65 ft	100 ft	130 ft	165 ft	195 ft	230 ft
<b>Diameter</b>	28.8 ft	44.3 ft	57.6 ft	73.2 ft	86.5 ft	102 ft
<b>Illumination</b>	46 fc	20 fc	12 fc	8 fc	6 fc	4 fc

## Remote control

- **Data protocol:** USITT DMX512-A

- **Data IN connector:** 5 pins XLR male
- **Data OUT connector:** 5 pins XLR femelle

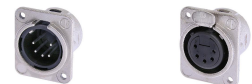

### • DMX chart:

#### Mode 1 (1 channels)

Dimmer

#### Mode 2 (2 channels)

Dimmer  
Dimmer master

#### Mode 3 (2 channels)

Lamp  
Dimmer

#### Mode 4 (3 channels)

Lamp  
Dimmer  
Dimmer master

## Dimensions and weight

### Unit

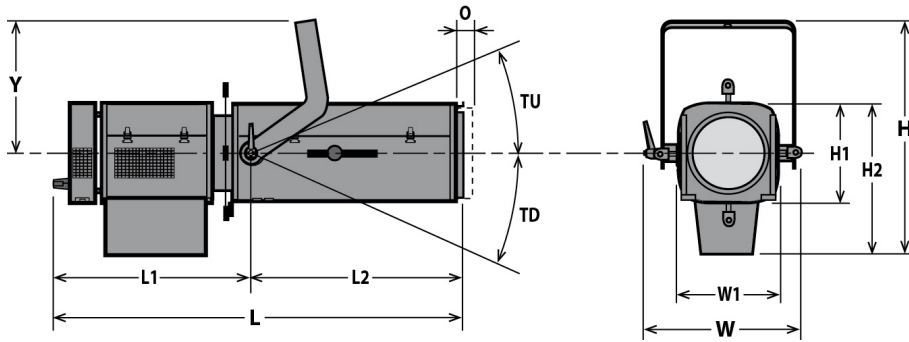

**Weight:** 33 kg (72.6 lbs)

Height	Length	Width	Yoke	Tilt	Option
H= 575 mm (22.6 in)	L= 1050 mm (41.3 in)	W= 415 mm (16.3 in)	Y= 325 mm (12.8 in)	TU= 60°	O= 25 mm (1 in)
H1= 250 mm (9.8 in)	L1= TBD mm (0 in)	W1= 250 mm (9.8 in)		TD= 50°	TO= 140°
H2= 375 mm (14.8 in)	L2= TBD mm (0 in)				

### Shipping

• **Weight :** 86.5 kg (190.3 lbs)

• **Volume :** .35 m<sup>3</sup> (12.36 ft<sup>3</sup>)

### PSU

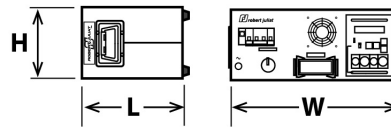

**Width:** W= 450 mm (17.7 in)

**Height:** H= 185 mm (7.3 in)

**Length:** L= 345 mm (13.6 in)

**Weight:** 34 Kg (74.8 lbs)

### Installation

• **Minimum distance to illuminated surface:** 2.0 m ( 6.6 ft )

• **Operating position:**

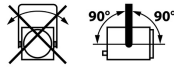

### Warranty

• **Fixture: 2 years**

*See General Sales Condition on website*

### Approvals



### Construction

- **Housing:** Steel sheet - Aluminium
- **Colour:** Black
- **Cooling:** Low noise fan
- **Maximum ambient temperature (Ta):** 40°C (104°F)
- **Maximum case temperature (Tc):** 220°C (428°F)
- **Total heat dissipation:** 10 581 BTU/h
- **Ingress Protection (IP) rating:** IP20

- **PSU housing:** Steel sheet - Aluminium
- **PSU colour:** Black
- **PSU cooling:** Fans
- **PSU maximum ambient temperature (Ta):** 40°C (104°F)
- **PSU maximum case temperature (Tc):** 70°C (158°F)

### Electrical compatibility

- 220/230 V - 50 Hz
- 245 V - 50 Hz
- ~~110/120 V - 60 Hz~~
- 208 V - 60 Hz
- ~~220/230 V - 60 Hz~~
- ~~100 V - 50 Hz~~
- ~~100 V - 60 Hz~~
- Selector: local switch

### Power input



- **Type:** attached power cord
- **Cable:** 12 AWG SJ type (UL/CSA)
- **Length:** 1.5 m (4.9 ft)
- **Power connector:** without connector

### Power consumption

Voltage	Frequency	Current	Power	Power factor
230 V	50 Hz		3100 W	
208 V	60 Hz		3100 W	
245 V	50 Hz		3100 W	

### Power Supply Unit

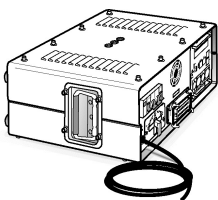

- **PSU:** Separate - Magnetic PSU
- **Lighting unit / PSU cable:** Removable cable - length: 3 m (9,8 ft)  
Type: 18G1,5 H07RNF with 16x16A+E Harting Han® connectors
- **Maximum distance between lighting unit and PSU:** 25 m (82 ft)
- **Control:** Local / DMX
- **Protection:** Mains: 25A 2P2D - C curve breaker - UL / Electronic: 6A 2P2D - C curve breaker - UL / Auxiliary: 1A 1P1D - C curve breaker - UL











## Model

**930CSNX**

2500 W HID Profile spot - 930CSNX D'Artagnan - 10/25° - Magnetic PSU - DMX dimmer and lamp control - 208V North american standard

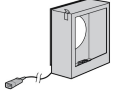
## Options

## Accessories

<b>D8</b>	Shutter for SX series <b>4 included</b>	
<b>SGUX</b>	Universal "A" size gobo-holder (metal, glass, frosted glass) <b>1 included</b>	
<b>VD120</b>	120x120mm frosted glass <b>1 included</b>	
<b>MSR 2500W HR</b>	MSR 2500W HR - Philips G38 2500W 500h 6000K lamp	
<b>IWSX755</b>	Drop-in iris (monoplane) with holder - Poids: 0.26 Kg	
<b>G1000C</b>	254x254mm safety grid	
<b>RVC934</b>	Front extension cassette for 254x254mm (10") accessories with fan - Poids: 2.59 Kg	
<b>FD900SNX</b>	Straight yoke - Poids: 2 Kg	
<b>876</b>	Hook clamp 40x10mm with 28mm M10 screw for Ø35 to 50mm pipes - SWL: 50Kg - Poids: 1.25 Kg	
<b>880</b>	Hook clamp 40x10mm with 28mm M10 screw for Ø50 to 63mm pipes - SWL: 50Kg - Poids: 1.36 Kg	
<b>MLA</b>	Mini yoke (with screws) - Poids: 0.9 Kg	
<b>CS2</b>	Safety cable Ø3 mm L= 600mm - SWL: 75 Kg	