

D'ARTAGNAN - 933CSNX

9005NX - 2500 W HID



- **Type:** Profile spot
- **Source:** 2500 W HID
- **PSU:** Magnetic - hot restrike - DMX
- **Optics:** 29° to 50° zoom
- **DMX-control of motorised dimmer shutter and lamp ignition**
- **Standard:** 208 V North american

Profile spot

The one to call on when you need power!

The 2500 W D'Artagnan is the most powerful of profiles: indispensable for dramatics effects at the opera, ideal for outdoor TV recordings, fashion shows and large trade fair stands. It is the benchmark among profile spots for all large scale shows and can be seen in spectaculars across the world.

Features

- **Multi-function double gate:** simultaneous use of gobos and iris. Sharp focus of both gobo and shutter
- **Shutter gate:** up to 8 shutters. Remove shutters for easy maintenance or tuck fully inside gate for secure transport
- **User-friendly shutter-lock system:** secures shutters' setting in any circumstances (locking efficient up to 4 shutters)
- **Universal gobo holder:** "A" size glass and metal gobo
- **Lens tube lock feature:** secures rotating lens tube against unwanted movement
- **90° rotating lens tube / gate / front accessories holder:** rotation of the projected image is always possible while the lamp remains vertical – no need to move the yoke
- **Built-in motorised dimmer shutter:** perfect and smooth dimming control from 0 to 100% by DMX
- **Internal glass filter holder:** long term use of durable coloured, dichroic or textured glass
- **DMX remote controlled ignition**
- **Easy focus reference:** graduated scale on side of the unit; fast and easy refocusing
- **Tilt reference on hanging yoke:** index for rapid re-positioning

Optical

- **Factory set optical train:** no re-alignment even after lamp change
- **SX optical system:** double condenser optics for exceptional optical quality
- **Gobo :** excellent gobo projection
- **Variable zoom optics:** sharp focus at every beam angle. Independent control of image size and focus. Focus handles on both sides

Construction

- **Made in France :** fully manufactured in Robert Juliat premises retaining complete control over all aspects of quality
- **Separate PSU:** compact for easy handling and rapid maintenance
- **Silent-running cooling fans:** ideal for TV studios and opera houses
- **Bodywork:** strong sheet metal construction for durability
- **Moving parts:** smooth at all times, even when hot
- **Captive knobs and handles:** additional security when working at height or in transit
- **Easy access to all parts:** easy cleaning, re-lamping and maintenance
- **Removable assemblies:** fast-plug cable connectors and complete component assemblies (mirror, condenser set and lamp house assembly) save maintenance and cleaning time
- **Spare parts and accessories:** interchangeable across the tungsten, discharge or LED ranges, reducing running costs

Picture:933SNX

DSEN081_933CSNX - 23/03/2022

Robert Juliat reserves the right to change or alter any of the items detailed on this page, to increase or improve manufacturing techniques without prior notice.

Robert Juliat S.A.S., 32 rue de Beaumont, 60530 Fresnoy-en-Thelle - France
Telephone : +33 (0)3 44 26 51 89 - fax : +33 (0)3 44 26 90 79 - info@robertjuliat.fr
www.robertjuliat.com



ROBERT JULIAT

Source



- **Lamp type:** Discharge
- **Power:** 2500 W
- **Socket:** G38
- **Hot re-strike:** yes

Admissible lamps	Power *	Lumen output*	Colour temperature*	Life*	CRI* (min)
CSR 2500W SEHR (GE)	2 500 W	220 000 lm	6000K	500 h	90
HMI 2500W/SE XS (Osram)	2 500 W	240 000 lm	6000K	500 h	90
MSR 2500W HR (Philips)	2 500 W	240 000 lm	6000K	500 h	95
USR 2500W HR (Ushio)	2 500 W	240 000 lm	5600K	500 h	80

(*) manufacturer's data

Optics

Characteristics

- **Type:** Zoom
- **Beam range:** 29° to 50°
- **Focal length:** 86 - 155 mm

Gel filter

- **Shape:** Square
- **Standard size:** 254x254 mm (10x10 in)

Gobo

- **Size:** A
- **Material:** Metal
Glass

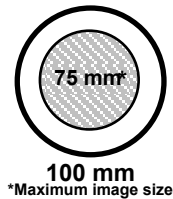

Photometrics

with MSR 2500W HR (Philips) source

• Optics @ 29°

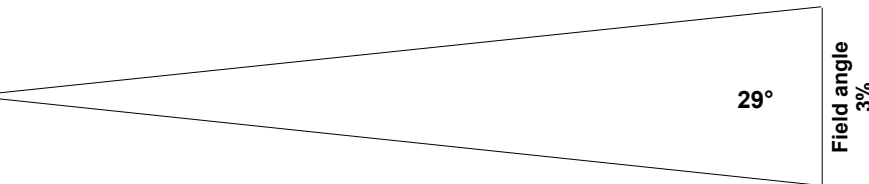
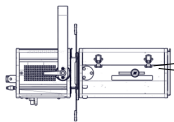

Beam intensity
213 000 cd

Distance	10 m	15 m	20 m	25 m	30 m	35 m
Diameter	5.2 m	7.8 m	10.3 m	12.9 m	15.5 m	18.1 m
Illumination	2 150 lux	950 lux	540 lux	350 lux	240 lux	180 lux
Distance	35 ft	50 ft	65 ft	80 ft	100 ft	115 ft
Diameter	18.1 ft	25.9 ft	33.6 ft	41.4 ft	51.7 ft	59.5 ft
Illumination	180 fc	90 fc	55 fc	34 fc	22 fc	17 fc

• Optics @ 50°

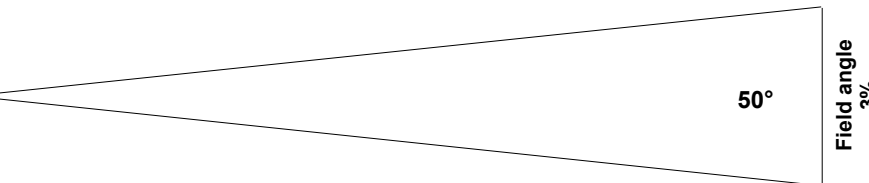
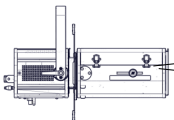

Beam intensity
61 500 cd

Distance	10 m	15 m	20 m	25 m	30 m	35 m
Diameter	9.3 m	14 m	18.7 m	23.3 m	28 m	32.6 m
Illumination	620 lux	280 lux	160 lux	100 lux	70 lux	55 lux
Distance	35 ft	50 ft	65 ft	80 ft	100 ft	115 ft
Diameter	32.6 ft	46.6 ft	60.6 ft	74.6 ft	93.3 ft	107.3 ft
Illumination	55 fc	25 fc	15 fc	10 fc	7 fc	5 fc

Remote control

- **Data protocol:** USITT DMX512-A

- **Data IN connector:** 5 pins XLR male
- **Data OUT connector:** 5 pins XLR femelle

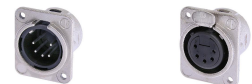

• DMX chart:

Mode 1 (1 channels)

Dimmer

Mode 2 (2 channels)

Dimmer
Dimmer master

Mode 3 (2 channels)

Lamp
Dimmer

Mode 4 (3 channels)

Lamp
Dimmer
Dimmer master

Dimensions and weight

Unit

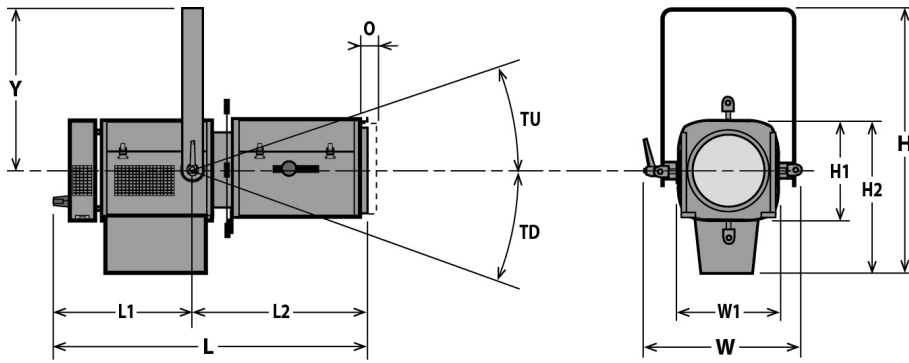

Weight: 28 kg (61.6 lbs)

Height	Length	Width	Yoke	Tilt	Option
H= 690 mm (27.2 in)	L= 720 mm (28.3 in)	W= 415 mm (16.3 in)	Y= 440 mm (17.3 in)	TU= 140°	O= 25 mm (1 in)
H1= 250 mm (9.8 in)	L1= TBD mm (0 in)	W1= 250 mm (9.8 in)		TD= 140°	TO= 60°
H2= 375 mm (14.8 in)	L2= TBD mm (0 in)				

Shipping

• **Weight:** 78.5 kg (172.7 lbs)

• **Volume:** .3 m³ (10.59 ft³)

PSU

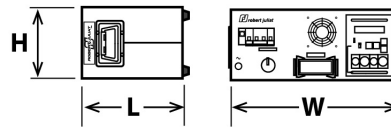

Width: W= 450 mm (17.7 in)

Height: H= 185 mm (7.3 in)

Length: L= 345 mm (13.6 in)

Weight: 34 Kg (74.8 lbs)

Installation

• **Minimum distance to illuminated surface:** 1.0 m (3.3 ft)

• **Operating position:**

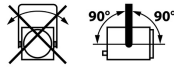

Warranty

• **Fixture:** 2 years

See General Sales Condition on website

Approvals



Construction

- **Housing:** Steel sheet - Aluminium
- **Colour:** Black
- **Cooling:** Low noise fan
- **Maximum ambient temperature (Ta):** 40°C (104°F)
- **Maximum case temperature (Tc):** 220°C (428°F)
- **Total heat dissipation:** 10 581 BTU/h
- **Ingress Protection (IP) rating:** IP20

- **PSU housing:** Steel sheet - Aluminium
- **PSU colour:** Black
- **PSU cooling:** Fans
- **PSU maximum ambient temperature (Ta):** 40°C (104°F)
- **PSU maximum case temperature (Tc):** 70°C (158°F)

Electrical compatibility

- 220/230 V - 50 Hz
- 245 V - 50 Hz
- ~~110/120 V - 60 Hz~~
- 208 V - 60 Hz
- ~~220/230 V - 60 Hz~~
- ~~100 V - 50 Hz~~
- ~~100 V - 60 Hz~~
- Selector: local switch

Power input



- **Type:** attached power cord
- **Cable:** 12 AWG SJ type (UL/CSA)
- **Length:** 1.5 m (4.9 ft)
- **Power connector:** without connector

Power consumption

Voltage	Frequency	Current	Power	Power factor
230 V	50 Hz		3100 W	
208 V	60 Hz		3100 W	
245 V	50 Hz		3100 W	

Power Supply Unit

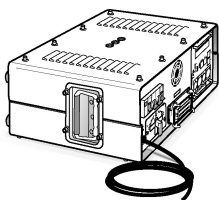

- **PSU:** Separate - Magnetic PSU
- **Lighting unit / PSU cable:** Removable cable - length: 3 m (9,8 ft)
Type: 18G1,5 H07RNF with 16x16A+E Harting Han® connectors
- **Maximum distance between lighting unit and PSU:** 25 m (82 ft)
- **Control:** Local / DMX
- **Protection:** Mains: 25A 2P2D - C curve breaker - UL / Electronic: 6A 2P2D - C curve breaker - UL / Auxiliary: 1A 1P1D - C curve breaker - UL











Model

933CSNX

2500 W HID Profile spot - 933CSNX D'Artagnan - 29/50° - Magnetic PSU - DMX dimmer and lamp control - 208V North american standard

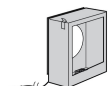
Options

Accessories

D8	Shutter for SX series 4 included	
SGUX	Universal "A" size gobo-holder (metal, glass, frosted glass) 1 included	
VD120	120x120mm frosted glass 1 included	
MSR 2500W HR	MSR 2500W HR - Philips G38 2500W 500h 6000K lamp	
IWSX755	Drop-in iris (monoplane) with holder - Poids: 0.26 Kg	
G1000C	254x254mm safety grid	
RVC934	Front extension cassette for 254x254mm (10") accessories with fan - Poids: 2.59 Kg	
FCD900SNX	Angled yoke - Poids: 1.7 Kg	
876	Hook clamp 40x10mm with 28mm M10 screw for Ø35 to 50mm pipes - SWL: 50Kg - Poids: 1.25 Kg	
880	Hook clamp 40x10mm with 28mm M10 screw for Ø50 to 63mm pipes - SWL: 50Kg - Poids: 1.36 Kg	
MLA	Mini yoke (with screws) - Poids: 0.9 Kg	
CS2	Safety cable Ø3 mm L= 600mm - SWL: 75 Kg	