

MANON - 1419C

COMPACT - 1200 W MSD



- **Type:** Followspot
- **Source:** 1200 W MSD
- **PSU:** Magnetic
- **Optics:** 13° to 24° zoom
- **Standard:** 208 V North american

Followspot

Economical yet full of features

The full range of features on Manon brings Robert Juliat quality within reach of all budgets. Long lamp life and low running costs provide a powerful, cost-effective solution for mid-size theatres, shows and rental companies alike.

Features

- **Fully closing iris cassette:** removable for fast, easy replacement; protective backplate for extended lifespan
- **Universal adjustable gobo holder:** "A" size glass and metal gobos
- **Ergonomic dimmer control:** one-handed dim, pan and tilt. Dimmer control can be adjusted to suit the operator's preference
- **Smooth dimmer shutter:** retains flat beam and colour temperature when dimming
- **Frost filter:** on flip lever for quick soft-edge beam effect
- **Horizontal chopper (optional):** for masking control in TV studios and wide stages
- **Internal glass filter holder:** long term use of durable coloured, dichroic or textured glass
- **Individually removable colour frame:** gels replaced easily while colour cassette remains in place
- **Colour changer:** 6-way, 'push/pull' colour changer system for simultaneous use of multiple filters
- **Easy focus reference:** graduated scale on side of the unit; fast and easy refocusing
- **Adjustable yoke (optional):** for optimum overhead positioning
- **Fine balance:** precision positioning and smooth operation even with the smallest movements
- **Stand:** perfectly weighted for maximum stability with smooth rotation for optimum performance. Easy set up; triple safety system for extra security

Optical

- **Long lamp life (3000 h)**
- **Factory set optical train:** travels safely within followspot and requires no time-consuming realignment on arrival. Uniform beam on all followspots of same type
- **SX optical system:** double condenser optics for exceptional optical quality
- **Gobo :** excellent gobo projection
- **Variable zoom optics:** sharp focus at every beam angle. Independent control of image size and focus.

Construction

- **Made in France :** fully manufactured in Robert Juliat premises retaining complete control over all aspects of quality
- **Separate PSU:** compact for easy handling and rapid maintenance
- **G22 socket locking system exclusive to Robert Juliat:** holds the lamp securely in place to ensure there is no arcing, even when the fixture is pointing vertically downward
- **Bodywork:** strong sheet metal construction for durability
- **Ergonomic wrap-around handle:** comfort, safety and practicality from all operating positions
- **Moving parts:** smooth at all times, even when hot
- **Captive knobs and handles:** additional security when working at height or in transit
- **Easy access to all parts:** easy cleaning, re-lamping and maintenance
- **Removable assemblies:** fast-plug cable connectors and complete component assemblies (mirror, condenser set and lamp house assembly) save maintenance and cleaning time

Picture:1419 + FRO/1117PV

DSEN110_1419C_208V - 23/03/2022

Robert Juliat reserves the right to change or alter any of the items detailed on this page, to increase or improve manufacturing techniques without prior notice.

Robert Juliat S.A.S., 32 rue de Beaumont, 60530 Fresnoy-en-Thelle - France
Telephone : +33 (0)3 44 26 51 89 - fax : +33 (0)3 44 26 90 79 - info@robertjuliat.fr
www.robertjuliat.com



ROBERT JULIAT

Source



- **Lamp type:** Discharge
- **Power:** 1200 W
- **Socket:** G22
- **Hot re-strike:** no

Admissible lamps	Power *	Lumen output*	Colour temperature*	Life*	CRI* (min)
MSD 1200W (Philips)	1 200 W	92 000 lm	6000K	3 000 h	80

(*) manufacturer's data

Optics

Characteristics

- **Type:** Zoom
- **Beam range:** 13° to 24°
- **Focal length:** 169 - 316 mm

Gel filter

- **Shape:** Circle
- **Standard size:** 210 mm (8.3 in)

Gobo

- **Size:** A
- **Material:** Metal
Glass



Photometrics

with MSD 1200W (Philips) source

• Optics @ 13°

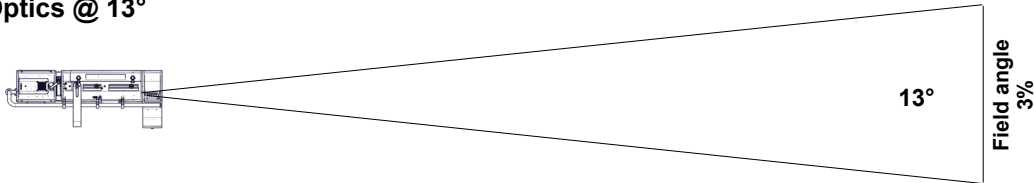

Beam intensity
650 000 cd

Distance	5 m	10 m	15 m	20 m	25 m	30 m
Diameter	1.1 m	2.3 m	3.4 m	4.6 m	5.7 m	6.8 m
Illumination	26 500 lux	6 600 lux	2 900 lux	1 650 lux	1 050 lux	730 lux
Distance	15 ft	35 ft	50 ft	65 ft	80 ft	100 ft
Diameter	3.4 ft	8 ft	11.4 ft	14.8 ft	18.2 ft	22.8 ft
Illumination	2 900 fc	540 fc	270 fc	160 fc	110 fc	70 fc

• Optics @ 24°

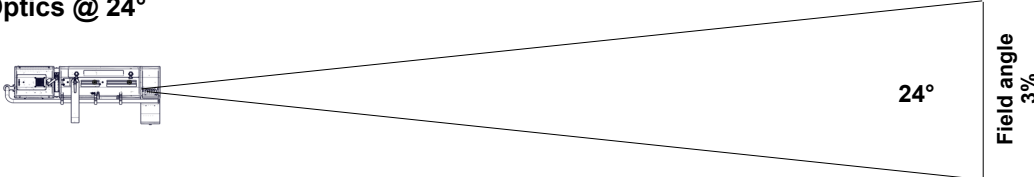

Beam intensity
230 000 cd

Distance	5 m	10 m	15 m	20 m	25 m	30 m
Diameter	2.1 m	4.3 m	6.4 m	8.5 m	10.6 m	12.8 m
Illumination	9 300 lux	2 350 lux	1 050 lux	580 lux	370 lux	260 lux
Distance	15 ft	35 ft	50 ft	65 ft	80 ft	100 ft
Diameter	6.4 ft	14.9 ft	21.3 ft	27.6 ft	34 ft	42.5 ft
Illumination	1 050 fc	190 fc	95 fc	55 fc	36 fc	24 fc

Dimensions and weight

Unit

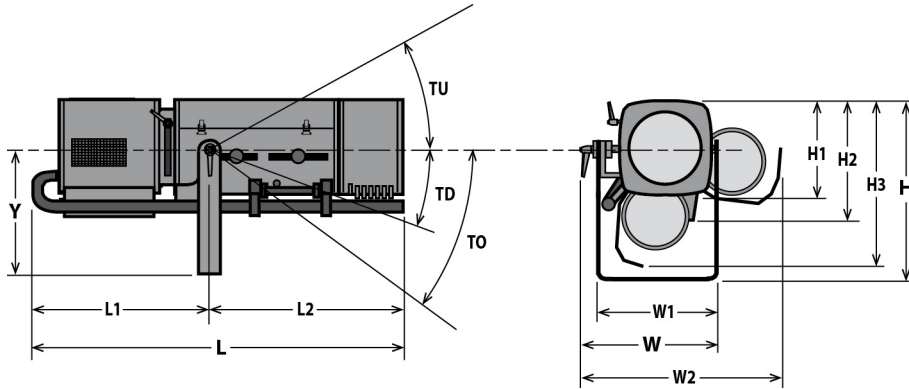

Weight: 30.2 kg (66.4 lbs)

Height	Length	Width	Yoke	Tilt	Option
H= 450 mm (17.7 in)	L= 900 mm (35.4 in)	W= 410 mm (16.1 in)	Y= 325 mm (12.8 in)	TU= 40°	TO= 70°
H1= 250 mm (9.8 in)	L1= 425 mm (16.7 in)	W1= 350 mm (13.8 in)		TD= 50°	
H2= 345 mm (13.6 in)	L2= 475 mm (18.7 in)	W2= 570 mm (22.4 in)			
H3= 460 mm (18.1 in)					

Shipping

- **Weight :** Unit: 35 kg (74.4 lbs)
PSU: 33.8 kg (74.4 lbs)
- **Volume :** Unit: .2 m³ (7.06 ft³)
PSU: .04 m³ (1.41 ft³)

PSU

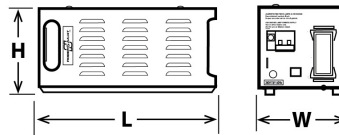

- Width:** W= 185 mm (7.3 in)
- Height:** H= 200 mm (7.9 in)
- Length:** L= 450 mm (17.7 in)
- Weight:** 23 Kg (50.6 lbs)

Installation

- **Minimum distance to illuminated surface:** 2.8 m (9.2 ft)
- **Operating position:**

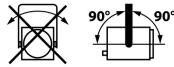

Warranty

- **Fixture: 2 years**
See General Sales Condition on website

Approvals



Construction

- **Housing:** Steel sheet - Aluminium
- **Colour:** Black
- **Cooling:** Low noise fan
- **Maximum ambient temperature (Ta):** 40°C (104°F)
- **Maximum case temperature (Tc):** 230°C (446°F)
- **Total heat dissipation:** 5 290 BTU/h
- **Ingress Protection (IP) rating:** IP20

- **PSU housing:** Steel sheet - Aluminium
- **PSU colour:** Black
- **PSU cooling:** Convection cooling
- **PSU maximum ambient temperature (Ta):** 40°C (104°F)
- **PSU maximum case temperature (Tc):** 60°C (140°F)

Electrical compatibility

- 220/230 V - 50 Hz
- 245 V - 50 Hz
- ~~110/120 V - 60 Hz~~
- 208 V - 60 Hz
- ~~220/230 V - 60 Hz~~
- ~~100 V - 50 Hz~~
- ~~100 V - 60 Hz~~
- Selector: local switch

Power input



- **Type:** attached power cord
- **Cable:** 12 AWG SJ type (UL/CSA)
- **Length:** 1.5 m (4.9 ft)
- **Power connector:** without connector

Power consumption

Voltage	Frequency	Current	Power	Power factor
230 V	50 Hz		1550 W	
208 V	60 Hz		1550 W	
245 V	50 Hz		1550 W	

Power Supply Unit

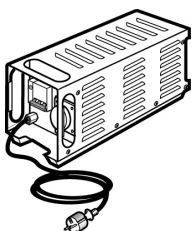





- **PSU:** Separate - Magnetic PSU
- **Lighting unit / PSU cable:** Cable attached to unit - length: 3 m (9,8 ft)
Type: 3G4 EWKF with 16A black 3P+E 7h IEC60309 connector
- **Maximum distance between lighting unit and PSU:** 25 m (82 ft)
- **Control:** Local
- **Protection:** Mains: 16A 2P2D - C curve breaker / Electronic: 10A 2P2D - C curve breaker









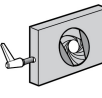

Model





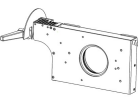











1419C 208V	1200 W MSD Followspot - 1419C Manon - 13/24° - Magnetic PSU - 208V North american standard
-------------------	--

Options

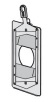
FRO/1117PV	Heavy duty adjustable yoke	
FRO/SMEPV	Heavy duty adjustable yoke equipped with TILT SpotMe sensor (E type)	
PG80	Ø80mm chopper kit (G80+ GR120+ adaptation kit)	
M210BM	6 ways "boomerang" colour changer	
FC1459	Flight-case for Compact range / GT stand / P.S.U. / accessories - Dim: 1340x710x700mm - Weight: 55 Kg	

Accessories

CCU1	Full closing iris cassette - Ø72mm - Poids: 1.33 Kg 1 included	
PF1011	Ø210 mm metal filter holder 6 included	
SGUP2	Universal "A" size gobo-holder (metal, glass, frosted glass) 1 included	
VDM100	Ø97mm frosted glass with holder 1 included	
M210T	6 ways "push/pull" colour changer - Poids: 3.67 Kg 1 included	
MSD 1200W	MSD 1200W - Philips G22 1200W 3000h 6000K lamp	
CCU1SM	Full closing iris cassette with position sensor for SpotMe system - Ø72mm	
GT1000	Tripod stand - SWL: 40 Kg - max. height: 1550 mm - Poids: 9.27 Kg	
GT4000	Tripod stand with safety chain - SWL: 130 Kg - max. height: 1030 mm - Poids: 7.91 Kg	
GT4000RSM	Tripod stand with ball head rotation with security chain and SpotMe PAN sensor - SWL: 130 Kg - max. height: 1030 mm	
GT4000S	Tripod stand without safety chain - SWL: 130 Kg - max. height: 1030 mm - Poids: 8.65 Kg	

JPP	Monopod stand for overhead followspot - Poids: 3.6 Kg	
T1000	TV spigot with followspots swivel head - Poids: 1.82 Kg	
T4000	Followspot mount for Ø50mm pipe (suspension or overhead) - SWL= 100 Kg - Poids: 4.88 Kg	
T4000RSM	Followspot mount with ball head rotation and SpotMe PAN sensor - SWL = 100 Kg - Poids: 8.53 Kg	
CAV700A	Double slot front cassette for 215x215mm accessories - Poids: 0.52 Kg	
CAV700NA	Single slot front holder for 254x254mm (10x10") accessories - Poids: 0.26 Kg	
FCM100R	Ø97mm 1/2 CTO correction filter (Rosco #3408) with holder	
VD120	120x120mm frosted glass	
FRO/1017PD	Heavy duty adjustable yoke - Poids: 4.33 Kg	
FRO/SMEPD	Heavy duty adjustable yoke equipped with TILT SpotMe sensor (E type)	
G80	Ø80mm horizontal chopper - Poids: 0.37 Kg	
GR120	Slot reducer for SGUP gobo holder (if PG80 option) - Poids: 0.2 Kg	
Kit G80	Ø80mm chopper kit (G80+ GR120+ adaptation kit) - Poids: 0.69 Kg	
M210B	6 ways "boomerang" colour changer - Poids: 3.36 Kg	
M210TVCL	Light shield for M210T push/pull colour changer - Poids: 1.98 Kg	
Kit TELRAD	Telrad followspot sight with raiser and universal mounting kit - Poids: 1.23 Kg	
SDUP	Followspot cue sheet holder with universal mounting kit	
TCSM	SpotMe calibration tool kit	
Maestro	Maestro server for SpotMe - rackable unit: 1U - half 19" - Poids: 1.2 Kg	

SMS

SpotMe server + 2 sensor cables + flight case

