

TIBO - 533CVW

500 - LED 30 W - VARIABLE WHITE



- **Type:** Profile spot
- **Source:** LED 30 W - Variable White
- **Optics:** 30° to 45° zoom
15° to 35° configuration possible
- **Colour temperature:** 2700K --> 5700K
- **Standard:** 110 V North american

Profile spot

Brighter and Smaller

Compact and lightweight LED profile. Tibo combines all the features and functions of a standard Robert Juliat lantern profile with an LED lightsource, ensuring a low power consumption whilst maintaining projection quality. It features an outstanding unique optical design that allows two different zoom ranges (15°-35° and 30°-45°) in one single unit. TIBO fits aesthetically into any application, from architectural to event applications as well as traditional entertainment lighting. The variable white version offers a finely-tuned control of colour temperatures.

Features

- **Shutter gate:** 4 shutters. Remove shutters for easy maintenance or tuck fully inside gate for secure transport
- **User-friendly shutter-lock system:** secures shutters' setting in any circumstances
- **Universal gobo holder:** m-size plastic, glass and metal gobos
- **Continuous 360° rotation of the fixture:** adjustment of the projected image is always possible
- **Parameters:** adjustable curves and response thru 4-button display with automatic light switch-off
- **DMX:** 8 or 16 bits dimming, CCT and strobe function
- **Control:** local and DMX
- **Tilt reference on hanging yoke:** index for rapid re-positioning

Optical

- **Very long-life lamp source:** 50 000 hours - Lumen maintenance greater than 70% after 50 000 hours
- **Efficient fixture:** up to 45 lm/W
- **Colour correction:** possibility to adjust the colour temperature from 2700K to 5700K
- **Coated double condenser optical system:** for exceptional optical quality
- **Variable zoom optics:** sharp focus at every beam angle. Independent control of image size and focus. Focus handles on both sides
- **Two different zoom ranges in one single unit:** 30/45° or 15/35° by adding/removing one lens - save on material costs and storage of separate lens tubes
- **Electronic dimmer:** dimming without clipping or cut-out at low intensity levels; high quality smoothing
- **No colour shift:** colour temperature remains the same when dimming

Construction

- **Made in France :** fully manufactured in Robert Juliat premises retaining complete control over all aspects of quality
- **Power connectors:** neutriK® powerCON TRUE1 IN and OUT connectors for daisy chaining
- **Separate electronic flicker-free PSU:** can be separate or on yoke
- **Silent-running cooling fans:** ideal for TV studios and opera houses
- **Electronic thermal management system:** ensures maximum performance of the system without any risk of overheating
- **Bodywork:** die cast aluminium housing
- **Captive knobs and handles:** additional security when working at height or in transit
- **Spare parts and accessories:** uniform across the tungsten, LED or HID TIBO range, reducing running costs
- **Easy access to lens tube without tool:** easy cleaning of zoom lenses

Picture:533

DSEN205_533CVW - 02/10/2018

Robert Juliat reserves the right to change or alter any of the items detailed on this page, to increase or improve manufacturing techniques without prior notice.

Robert Juliat S.A.S., 32 rue de Beaumont, 60530 Fresnoy-en-Thelle - France
Telephone : +33 (0)3 44 26 51 89 - fax : +33 (0)3 44 26 90 79 - info@robertjuliat.fr
www.robertjuliat.com



ROBERT JULIAT

Source



- Lamp type: LED
- Power: 30 W

LED specifications	Power *	Lumen output*	Colour temperature*	Life*	CRI* (min)
Tibo 30W VW (Robert Juliat)	30 W	2 000 lm	2700K --> 5700K	50 000 h	92

(*) manufacturer's data

Optics

Characteristics

- Type: Zoom
- Beam range: 30° to 45°
15° to 35° configuration possible
- Focal length: 68 - 105 mm

Gel filter

- Shape: Square
- Standard size: 138x138 mm (5.4x5.4 in)

Gobo

- Size: M
- Material: Metal
Glass
Plastic

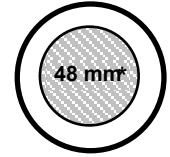

66 mm
*Maximum image size

Photometrics

with Tibo 30W VW (Robert Juliat) source

• Optics @ 30°

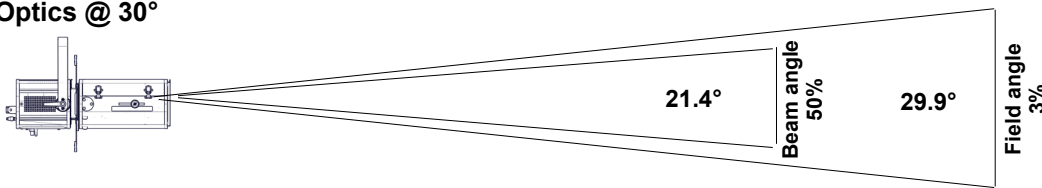

Beam intensity
10 800 cd

Field lumens
1 310 lm

Efficacy
39 lm/W

CCT
4 050 K

CRI
97

Distance	3 m	5 m	7 m	10 m	12 m	15 m
Diameter	1.6 m	2.7 m	3.7 m	5.3 m	6.4 m	8 m
Illumination	1 250 lux	440 lux	230 lux	110 lux	80 lux	49 lux
Distance	10 ft	15 ft	25 ft	35 ft	40 ft	50 ft
Diameter	5.3 ft	8 ft	13.4 ft	18.7 ft	21.4 ft	26.7 ft
Illumination	110 fc	49 fc	18 fc	9 fc	7 fc	5 fc

• Optics @ 45°

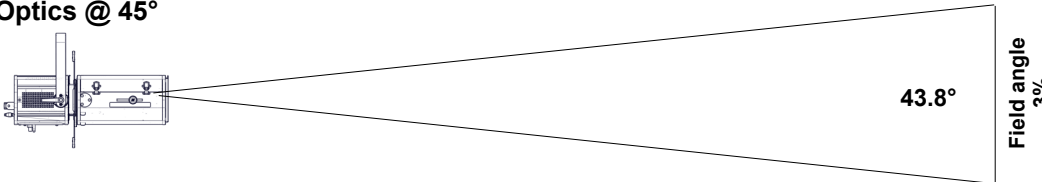

Beam intensity
6 050 cd

CCT
4 040 K

Distance	3 m	5 m	7 m	10 m	12 m	15 m
Diameter	2.4 m	4 m	5.6 m	8 m	9.6 m	12.1 m
Illumination	680 lux	250 lux	130 lux	65 lux	43 lux	27 lux
Distance	10 ft	15 ft	25 ft	35 ft	40 ft	50 ft
Diameter	8 ft	12.1 ft	20.1 ft	28.1 ft	32.2 ft	40.2 ft
Illumination	65 fc	27 fc	10 fc	5 fc	4 fc	3 fc

Remote control

- Data protocol: USITT DMX512-A
RDM / Art-Net / sACN

- Data IN connector: 5 pins XLR male
- Data OUT connector: 5 pins XLR female



• DMX chart:

Mode 1 (1 channels)	Mode 2 (4 channels)	Mode 3 (5 channels)	Mode 4 (5 channels)
Dimmer	Dimmer	Dimmer	Warm White
	Dimmer fine	Dimmer fine	Warm White fine
	CCT	CCT	Cool White
	Strobe	Strobe	Cool White fine
		Dimmer master	Strobe

Dimensions and weight

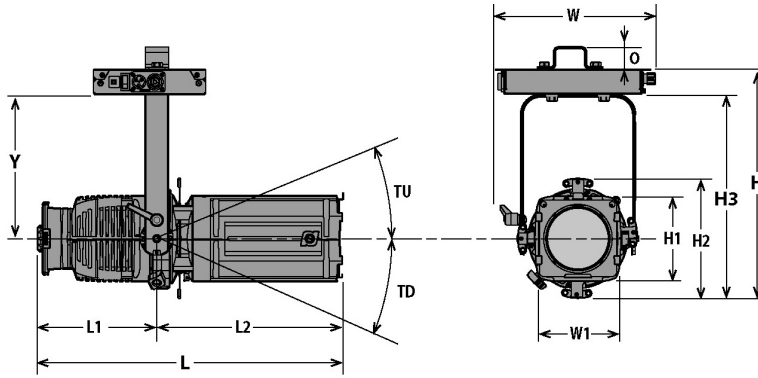

Weight: 10 kg (22 lbs)

with PSU

Height	Length	Width	Yoke	Tilt	Option
H= 407 mm (16 in)	L= 526 mm (20.7 in)	W= 289 mm (11.4 in)	Y= 245 mm (9.6 in)	TU= 55°	O= 30 mm (1,2 in)
H1= 150 mm (5.9 in)	L1= 200 mm (7.9 in)	W1= 150 mm (5.9 in)		TD= 90°	
H2= 226 mm (8.9 in)	L2= 326 mm (12.8 in)				
H3= 363 mm (14.3 in)					

Shipping

• **Weight :** 12.2 kg (26.8 lbs)

• **Volume :** .05 m³ (1.77 ft³)

PSU

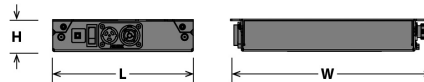

Width: W= 271 mm (10.7 in)

Height: H= 44 mm (1.7 in)

Length: L= 195 mm (7.7 in)

Weight: 2.4 Kg (5.3 lbs)

Installation

• **Minimum distance to illuminated surface:** 0.7 m (2.3 ft)

• **Operating position:**

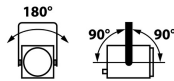

Warranty

• **Period: 2 years**
See General Sales Condition on website

Approvals



Construction

- **Housing:** Die cast aluminium
- **Colour:** Black
- **Cooling:** Low noise variable fan
- **Maximum ambient temperature (Ta):** 40°C (104°F)
- **Maximum case temperature (Tc):** 60°C (140°F)
- **Total heat dissipation:** 123 BTU/h
- **Protection rating:** 20

- **PSU housing:** Steel sheet - Aluminium
- **PSU colour:** Black
- **PSU cooling:** Convection cooling
- **PSU maximum ambient temperature (Ta):** 40°C (104°F)
- **PSU maximum case temperature (Tc):** 50°C (122°F)

Electrical compatibility

- 220/230 V - 50 Hz
- 245 V - 50 Hz
- 110/120 V - 60 Hz
- 208 V - 60 Hz
- 220/230 V - 60 Hz
- 100 V - 50 Hz
- 100 V - 60 Hz
- Selector: automatic detection

Power input



- **Type:** removeable power cord with Neutrik powerCON TRUE1 connector (included)
- **Cable:** 14 AWG SJ type (UL/CSA)
- **Length:** 1,5 m (4,9 ft)
- **Power connector:** without connector

Power consumption

Voltage	Frequency	Current	Power	Power factor
230 V	50 Hz	0.17 A	36 W	>0.84
120 V	60 Hz	0.3 A	36 W	
100 V	60 Hz	0.36 A	36 W	

Power Supply Unit



- **PSU:** On yoke - Electronic PSU - Flicker free with PFC
- **Lighting unit / PSU cable:** Cable attached to unit - length: 1,5 m (4,9 ft)
Type: 3M ref. 3696 with 12 pins M16 locking connector
- **Maximum distance between lighting unit and PSU:** 5 m (16 ft)
- **Control:** Local / DMX
- **Protection:** Mains: 4A 1P1D breaker - UL /
- **Power thru:** Neutrik powerCON TRUE1 - Maximum of 35 units (230 V) / 20 units (120 V)





Model

533CVW	LED 30 W - Variable White Profile spot - 533CVW Tibo - 30/45° - North american standard
---------------	---

Options

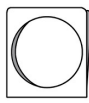
T-RAL9010	White housing (RAL 9010)	
------------------	--------------------------	---

Accessories

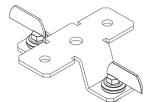
D4	Shutter for Tibo series 4 included	
PF100M	135x135mm metal filter holder 1 included	
IS500	Drop-in iris (monoplane) with holder	
EXT/TiboVW	12 pins Tibo LED variable white extension cable - length = 3.m (138")	
SGUT	Universal "M" size gobo-holder (metal, glass, frosted glass)	
872	Doughty "Twenty clamp" with M10 screw/nut for Ø48 to 51mm pipes - SWL: 20Kg - TÜV approved - Weight: ,25 Kg	
878	Hook clamp 25x6mm with 23mm M10 screw for Ø35 to 50mm pipes - SWL: 11Kg - Weight: ,46 Kg	
OmegaT2	Omega bracket with quarter turn bolt sets for PSU - Weight: ,42 Kg	
CS2	Safety cable Ø3 mm L= 600mm - SWL: 75 Kg	