

CHARLES - 961CSX

960SX - LED 600 W



- **Type:** Profile spot
- **Source:** LED 600 W
- **Optics:** 8° to 16° zoom
- **Colour temperature:** Cool White
- **Standard:** 110 V North american

Profile spot

The bright new classic in LED profile technology with mighty output

Sharing its technology, output and quality of light with Oz and Alice, Robert Juliat presents its brilliant range of LED profiles, the Charles 960SX series. This range of 600W LED profiles is available in 3 variable zoom ranges and exhibits a high optical efficiency with a 6000K colour temperature and a CRI in excess of 90. Smooth electronic dimming and an in-built, flicker-free power supply gives silent operation and packs a high output that reaches 80% of the renowned 2.5 kW HID D'Artagnan capabilities.

Features

- **Multi-function double gate:** simultaneous use of gobos and iris. Sharp focus of both gobo and shutter
- **Shutter gate:** up to 8 shutters. Remove shutters for easy maintenance or tuck fully inside gate for secure transport
- **User-friendly shutter-lock system:** secures shutters' setting in any circumstances (locking efficient up to 4 shutters)
- **Universal gobo holder:** "A" size glass and metal gobo
- **Gate lock feature:** secures rotating gate against unwanted movement
- **90° rotating gate :** rotation of the projected image is always possible – no need to move the yoke
- **Internal glass filter holder:** long term use of durable coloured, dichroic or textured glass
- **XLR7 connector:** for fan cooled front extension cassette (recommended for dark colours)
- **Adjustable response time:** choice of fast or slow dimming for tungsten-like simulation - adjustment by DMX protocol
- **Universal data control:** compatible with DMX, RDM, Art-Net, sACN protocols
- **Remote setup:** all parameters can be adjusted by RDM protocol
- **DMX:** 8 or 16 bit dimming and strobe function
- **Local setup:** DMX address and mode, dimming curve and response time through 4-button display with automatic light switch-off
- **Control:** local and DMX
- **Dimming parameters:** choice of square or linear dimming curves
- **Easy focus reference:** graduated scale on side of the unit; fast and easy refocusing
- **Tilt reference on hanging yoke:** index for rapid re-positioning

Optical

- **Long life:** outstanding operational lifetime expectation, no need to replace lamps, low maintenance
- **Gobo :** excellent gobo projection
- **Variable zoom optics:** sharp focus at every beam angle. Independent control of image size and focus. Focus handles on both sides
- **Electronic dimmer:** dimming without clipping or cut-out at low intensity levels; high quality smoothing
- **No colour shift:** colour temperature remains the same when dimming

Construction

- **Made in France :** fully manufactured in Robert Juliat premises retaining complete control over all aspects of quality
- **PSU:** built-in electronic flicker-free power supply for easy, plug-and-play installation
- **Power connectors:** compatible powerCON® TRUE1 IN and OUT connectors for daisy chaining
- **Silent-running cooling fans:** ideal for TV studios and opera houses
- **Electronic thermal management system:** ensures maximum performance of the system without any risk of overheating
- **Bodywork:** strong sheet metal construction for durability
- **Moving parts:** smooth at all times, even when hot
- **Captive knobs and handles:** additional security when working at height or in transit
- **Spare parts and accessories:** interchangeable across the tungsten, discharge or LED ranges, reducing running costs
- **Easy access to all parts:** easy cleaning and maintenance

Picture:961SX

DSEN353_961CSX - 08/11/2024

Robert Juliat reserves the right to change or alter any of the items detailed on this page, to increase or improve manufacturing techniques without prior notice.

Robert Juliat S.A.S., 32 rue de Beaumont, 60530 Fresnoy-en-Thelle - France
Telephone : +33 (0)3 44 26 51 89 - info@robertjuliat.fr - www.robertjuliat.com



ROBERT JULIAT

- Lamp type: LED
- Power: 600 W

LED specifications	Power *	Lumen output*	Colour temperature*	Life*	CRI* (min)
LED 600W	600 W	32 500 lm	6000K	20 000 h	91

(*) manufacturer's data

Optics

Characteristics

- Type: Zoom
- Range: 8° to 16° (Field angle)
- Focal length: 285 - 572 mm

Gel filter

- Shape: Square
- Standard size: 254x254 mm (10x10 in)

Gobo

- Size: A
- Material: Metal
Glass

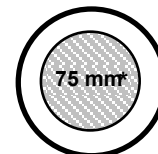

100 mm
*Maximum image size

Photometrics

optics: 8°-16° / Standard

• Optics @ 8°

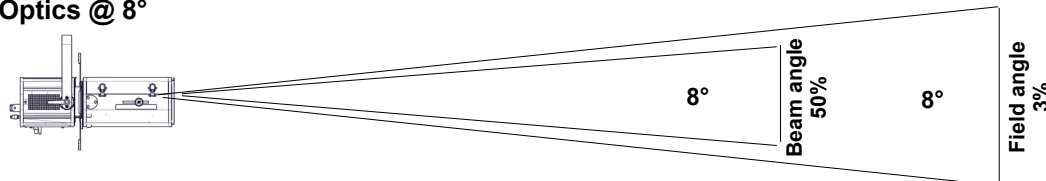

Beam intensity
1 036 300 cd

Field lumens
12 850 lm

Efficacy
20 lm/W

Distance	10 m	20 m	30 m	40 m	50 m	60 m
Diameter	1.4 m	2.8 m	4.2 m	5.6 m	7 m	8.4 m
Illumination	10 500 lux	2 600 lux	1 200 lux	650 lux	420 lux	290 lux
Distance	35 ft	65 ft	100 ft	130 ft	165 ft	195 ft
Diameter	4.9 ft	9.1 ft	14 ft	18.2 ft	23.1 ft	27.3 ft
Illumination	850 fc	250 fc	110 fc	65 fc	39 fc	28 fc

• Optics @ 16°

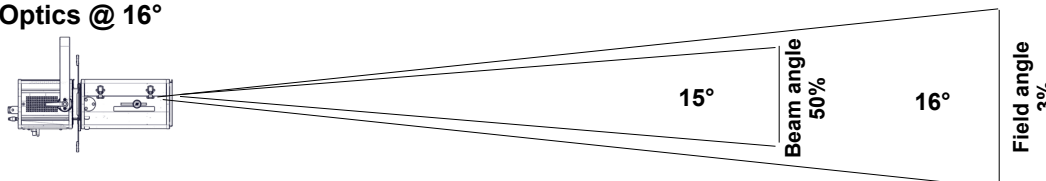

Beam intensity
314 500 cd

Field lumens
14 300 lm

Efficacy
22 lm/W

Distance	10 m	20 m	30 m	40 m	50 m	60 m
Diameter	2.8 m	5.6 m	8.4 m	11.2 m	14.1 m	16.9 m
Illumination	3 150 lux	790 lux	350 lux	200 lux	130 lux	90 lux
Distance	35 ft	65 ft	100 ft	130 ft	165 ft	195 ft
Diameter	9.8 ft	18.3 ft	28.1 ft	36.5 ft	46.4 ft	54.8 ft
Illumination	260 fc	75 fc	32 fc	19 fc	12 fc	9 fc

Remote control

- Data protocol: USITT DMX512-A
RDM / Art-Net / sACN

- Data IN connector: 5 pins XLR male + etherCON RJ45
- Data OUT connector: 5 pins XLR female



• DMX chart:

Mode 1 (1 channels)

Dimmer

Mode 2 (2 channels)

Dimmer
Dimmer fine

Mode 3 (5 channels)

Dimmer
Strobe duration
Strobe speed
Response time
Control mode

Mode 4 (6 channels)

Dimmer
Dimmer fine
Strobe duration
Strobe speed
Response time
Control mode

Dimensions and weight

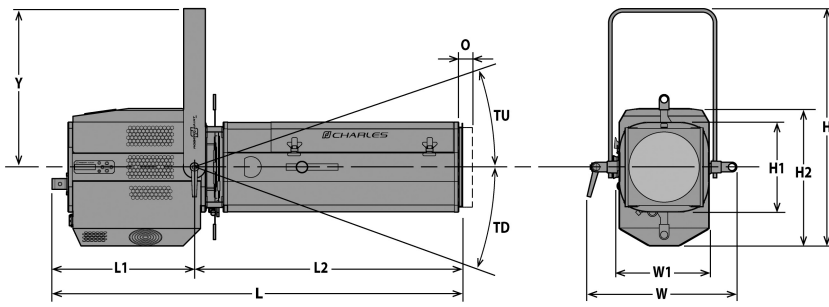

Weight: 35.2 kg (77.4 lbs)

Height	Length	Width	Yoke	Tilt	Option
H= 659 mm (25.9 in)	L= 1139 mm (44.8 in)	W= 368 mm (14.5 in)	Y= 440 mm (17.3 in)	TU= 68°	O= 25 mm (1 in)
H1= 250 mm (9.8 in)	L1= 395 mm (15.6 in)	W1= 250 mm (9.8 in)		TD= 90°	
H2= 381 mm (15 in)	L2= 744 mm (29.3 in)				

Shipping

- **Weight :** 47 kg (103.4 lbs)
- **Volume :** .35 m³ (12.36 ft³)

Installation

- **Minimum distance to illuminated surface:** 0.2 m (0.7 ft)
- **Operating position:**

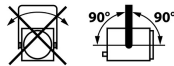

Construction

- **Housing:** Steel sheet - Aluminium
- **Colour:** Black
- **Cooling:** Variable fans
- **Maximum ambient temperature (Ta):** 40°C (104°F)
- **Maximum case temperature (Tc):** 65°C (149°F)
- **Total heat dissipation:** 2 184 BTU/h
- **Ingress Protection (IP) rating:** IP20

Electrical compatibility

- 220/230 V - 50 Hz
- 245 V - 50 Hz
- 110/120 V - 60 Hz
- 208 V - 60 Hz
- 220/230 V - 60 Hz
- 100 V - 50 Hz
- 100 V - 60 Hz
- Selector: automatic detection

Power input



- **Type:** removable power cord with compatible powerCON® TRUE1 connector (included)
- **Cable:** 14 AWG SJ type (UL/CSA)
- **Length:** 1.5 m (4.9 ft)
- **Power connector:** without connector

Power consumption

Voltage	Frequency	Current	Power	Power factor
230 V	50 Hz	2.8 A	640 W	0.99
120 V	60 Hz	5.5 A	649 W	0.99
100 V	60 Hz	6.7 A	655 W	0.99

Power Supply Unit

- **PSU:** Internal - Electronic PSU - Flicker free with PFC
- **Control:** Local / DMX
- **Protection:** Mains: 10A 1P1D breaker - UL /
- **Power thru:** compatible powerCON® TRUE1 - Maximum of 5 units (230 V) / 2 units (120 V)

Warranty

- **Fixture: 3 years**
See General Sales Condition on website

Approvals



Acoustics

- **Noise level:** < 39,9 dB(A)













Model

961CSX

LED 600 W Profile spot - 961CSX Charles - Cool White - 8/16° - North american standard

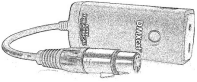
Options

Accessories

D8	Shutter for SX series 4 included	
SGUX	Universal "A" size gobo-holder (metal, glass, frosted glass) 1 included	
IWSX755	Drop-in iris (monoplane) with holder - Weight: 0.26 Kg	
D8	Shutter for SX series	
G1000C	254x254mm safety grid	
RPF960C	Front extension cassette for 254x254mm (10") accessories with XLR7 fan (recommended for dark colours on 960SX) - Weight: 1.7 Kg	
VD120	120x120mm frosted glass	
FCD700	Angled yoke - Weight: 1.62 Kg	
DMXcat	Bluetooth DMX/RDM Multifunction test tool - City Theatrical DMXcat®	
876	Hook clamp 40x10mm with 28mm M10 screw for Ø35 to 50mm pipes - SWL: 50Kg - Weight: 1.25 Kg	
880	Hook clamp 40x10mm with 28mm M10 screw for Ø50 to 63mm pipes - SWL: 50Kg - Weight: 1.36 Kg	
CS2	Safety cable Ø3 mm L= 600mm - SWL: 75 Kg	

Light quality report

CCT	DeltaUV	CRI Ra	CRI R9	CQS Qa	TM30-18 Rf	TM30-18 Rg	TLCI
5 770K	0.0033	90	51	88	88	96	89

CRI - CIE Colour Rendering Index

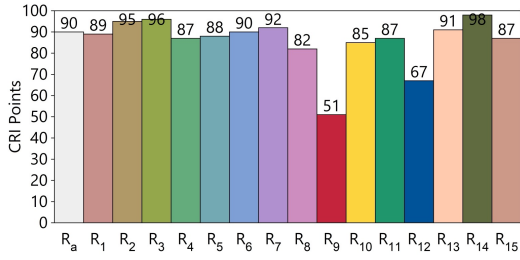

TLCI - Television Lighting Consistency Index

Test : CCT = D5770 (0.0)
 TLCI-2012 : 89 (D5770)

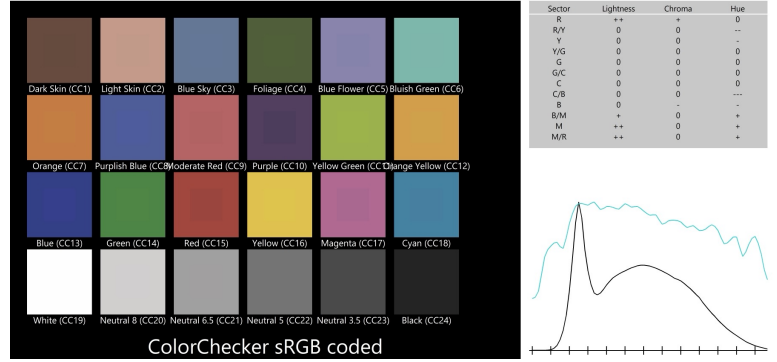

CQS - NIST Colour Quality Scale

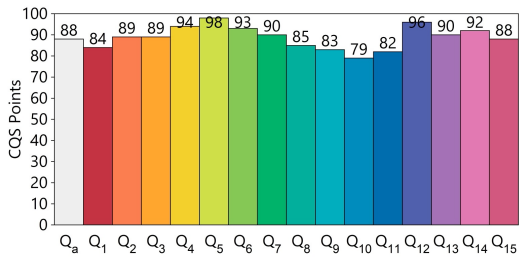

ANSI/IES TM-30-18 Colour Rendition Report

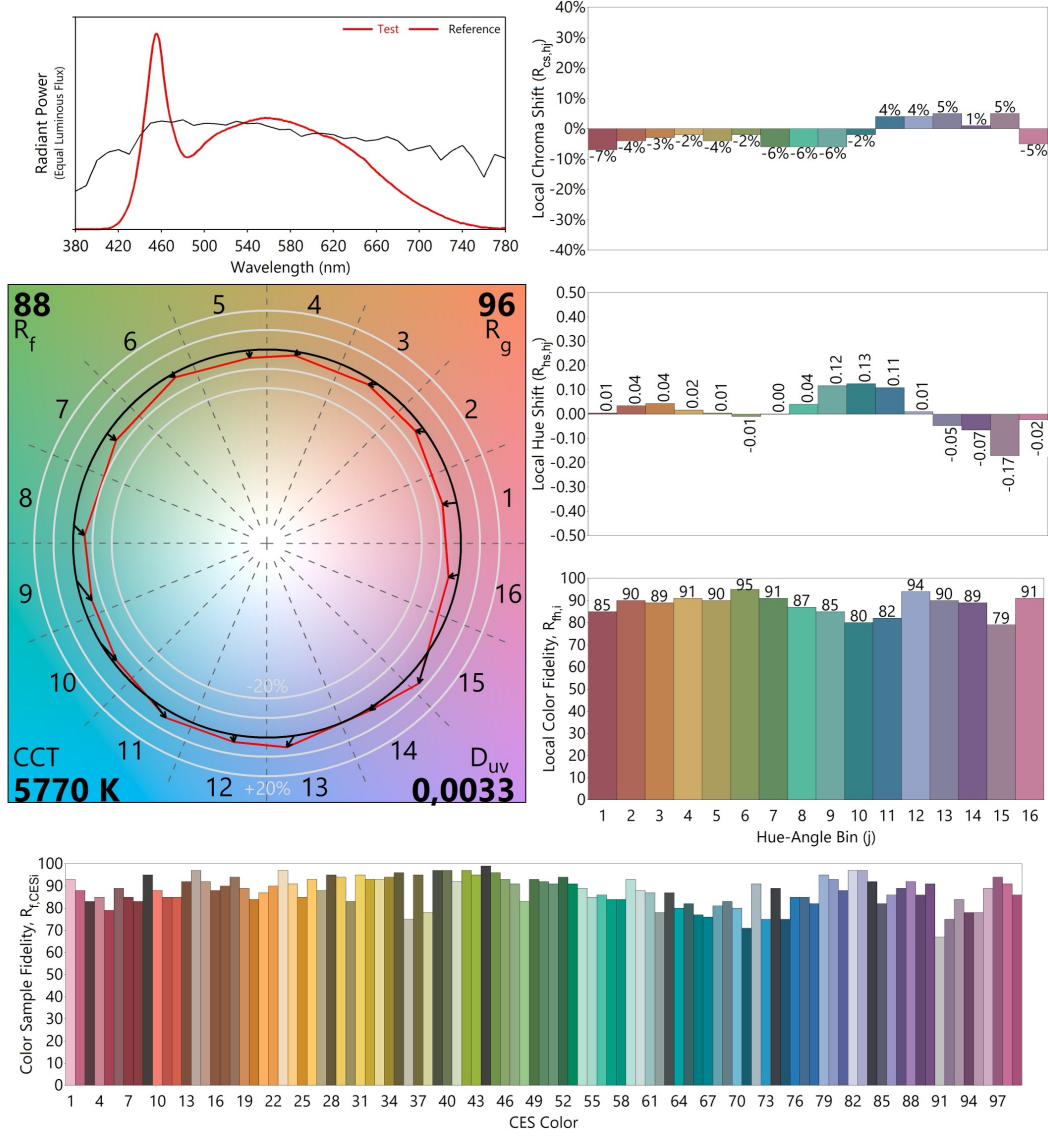

Colours are for visual orientation purposes only. Created with the IES TM-30-18 Calculator Version 2.00