

# 329HF

329 - 2000/2500 W TUNGSTEN



- **Type:** Single lens luminaire
- **Source:** 2000/2500 W Tungsten
- **Optics:** 200 mm Fresnel lens

Single lens

## The industry standard for 2.5K units

329H is a favourite in theatres, opera houses and concert halls the world over.

A G22 lamp socket holds the lamp securely in place giving reliability, longer lamp life and 2000 W or 2500 W lamp options. Ideal for medium to large venues and rental companies.

### Features

- **Theatre front cassette:** no light spill to distract audiences or performers
- **Accessories holder:** double runners to hold accessories and colour filters
- **Barn door:** unique rotating barn door with 4 individually rotating blades – makes even the most difficult angle possible
- **Focus adjustment:** smooth focus adjustment from front or rear, even when lantern is hot, for a longer lamp life
- **Tilt reference on hanging yoke:** index for rapid re-positioning

### Optical

- **G22 socket:** accepts 2000 W and 2500 W lamps
- **200 mm lens:** compact size 2 / 2.5 KW fixture

### Construction

- **Made in France :** fully manufactured in Robert Juliat premises retaining complete control over all aspects of quality
- **Air vents:** efficient cooling with no light spill
- **Bodywork:** strong sheet metal construction for durability
- **Moving parts:** smooth at all times, even when hot
- **Captive knobs and handles:** additional security when working at height or in transit
- **Access:** easy access to lamp house and lenses through front opening for fast and efficient maintenance
- **Easy access to all parts:** easy cleaning, re-lamping and maintenance
- **Safety grid:** earthed safety grid fitted as standard
- **Safety first:** front accessories safety cable attachment point

Picture:329H

DSEN023\_329HF - 03/04/2025

Robert Juliat reserves the right to change or alter any of the items detailed on this page, to increase or improve manufacturing techniques without prior notice.

Robert Juliat S.A.S., 32 rue de Beaumont, 60530 Fresnoy-en-Thelle - France  
Telephone : +33 (0)3 44 26 51 89 - info@robertjuliat.fr - www.robertjuliat.com



ROBERT JULIAT

## Source



- **Lamp type:** Tungsten
- **Socket:** G22

Admissible lamps	Power *	Lumen output*	Colour temperature*	Life*
LIF: CP92	2 000 W	52 000 lm	3200K	400 h
LIF: CP91	2 500 W	65 000 lm	3200K	400 h

(\*) manufacturer's data

## Optics

### Characteristics

- **Type:** Single lens
- **Range:** 7° to 49° (Beam angle)
- **Lens:** 200 mm Fresnel lens

### Gel filter

- **Shape:** Square
- **Standard size:** 245x245 mm (9.6x9.6 in)

## Photometrics

optics: 7°-49° / Standard / LIF: CP91 2500W

### • Optics @ 7°

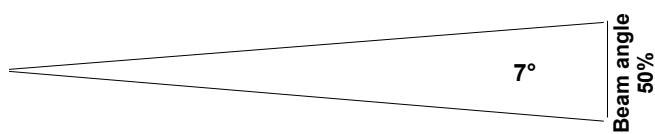
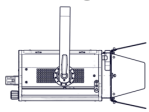

**Beam intensity**  
340 000 cd

<b>Distance</b>	5 m	10 m	15 m	20 m	25 m	30 m
<b>Diameter</b>	0.6 m	1.2 m	1.8 m	2.4 m	3.1 m	3.7 m
<b>Illumination</b>	14 000 lux	3 450 lux	1 550 lux	860 lux	550 lux	380 lux
<b>Distance</b>	15 ft	35 ft	50 ft	65 ft	80 ft	100 ft
<b>Diameter</b>	1.8 ft	4.3 ft	6.1 ft	8 ft	9.8 ft	12.2 ft
<b>Illumination</b>	1 550 fc	280 fc	140 fc	85 fc	55 fc	35 fc

### • Optics @ 49°

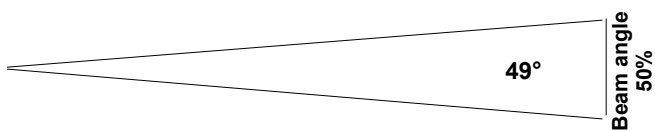
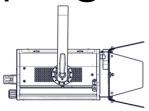

**Beam intensity**  
44 000 cd

<b>Distance</b>	5 m	10 m	15 m	20 m	25 m	30 m
<b>Diameter</b>	4.6 m	9.1 m	13.7 m	18.2 m	22.8 m	27.3 m
<b>Illumination</b>	1 800 lux	450 lux	200 lux	120 lux	75 lux	49 lux
<b>Distance</b>	15 ft	35 ft	50 ft	65 ft	80 ft	100 ft
<b>Diameter</b>	13.7 ft	31.9 ft	45.6 ft	59.2 ft	72.9 ft	91.1 ft
<b>Illumination</b>	200 fc	36 fc	18 fc	11 fc	7 fc	5 fc

## Dimensions and weight

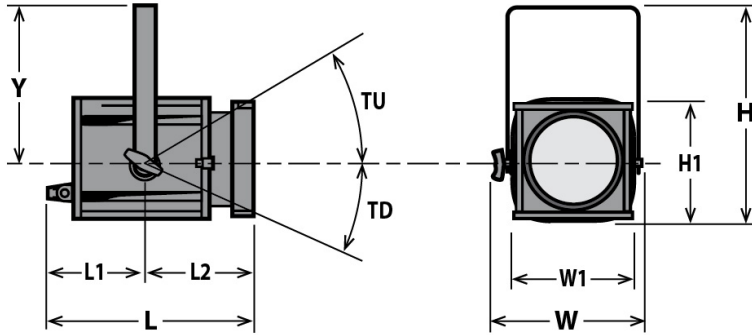

**Weight:** 14 kg (30.8 lbs)

Height	Length	Width	Yoke	Tilt
H= 520 mm (20.5 in) H1= 320 mm (12.6 in)	L= 470 mm (18.5 in) L1= 285 mm (11.2 in) L2= 185 mm (7.3 in)	W= 410 mm (16.1 in) W1= 320 mm (12.6 in)	Y= 345 mm (13.6 in)	TU= TBD° TD= TBD°

## Shipping

- **Weight :** 15 kg (33 lbs)
- **Volume :** .09 m<sup>3</sup> (3.18 ft<sup>3</sup>)

## Installation

- **Minimum distance to illuminated surface:** 2.7 m ( 8.9 ft )
- **Operating position:**



## Construction

- **Housing:** Steel sheet - Aluminium
- **Colour:** Black
- **Cooling:** Convection cooling
- **Maximum ambient temperature (Ta):** 40°C (104°F)
- **Maximum case temperature (Tc):** 250°C (482°F)
- **Total heat dissipation:** 6 826 BTU/h
- **Ingress Protection (IP) rating:** IP20

## Electrical compatibility

- 230/240 V - 50 Hz
- ~~115/120 V - 60 Hz~~

## Power input



- **Type:** attached power cord
- **Cable:** H07RNF 3G1.5
- **Length:** 3 m (9.8 ft)
- **Power connector:** CEE 7/7 (2P+E NF/Schuko)

## Power consumption

Voltage	Frequency	Current	Power
230 V	50 Hz	9 A	2000 W
230 V	50 Hz	11 A	2500 W

## Warranty

- **Fixture: 2 years**  
See General Sales Condition on website

## Approvals











## Model

<b>329HF</b>	2000/2500 W Tungsten Single lens luminaire - G22 socket - 200mm Fresnel - 329HF
--------------	---

## Options

<b>PCP1716A</b>	16A blue 2P+E 6h IEC60309 power connector	
-----------------	---	---

## Accessories

<b>PF329M</b>	245x245mm metal filter holder - Weight: 0.23 Kg <b>1 included</b>	
<b>G329</b>	245x245mm safety grid <b>1 included</b>	
<b>CP91</b>	CP91 - G22 2500W 230V 400h 3200K lamp	
<b>CP92</b>	CP92 - G22 2000W 230V 400h 3200K lamp	
<b>CF329</b>	4 rotating leaves on a rotating barndoor - 245x245mm (without safety cable) - Weight: 1.42 Kg	
<b>876</b>	Hook clamp 40x10mm with 28mm M10 screw for Ø35 to 50mm pipes - SWL: 50Kg - Weight: 1.25 Kg	
<b>880</b>	Hook clamp 40x10mm with 28mm M10 screw for Ø50 to 63mm pipes - SWL: 50Kg - Weight: 1.36 Kg	
<b>CS2</b>	Safety cable Ø3 mm L= 600mm - SWL: 75 Kg	
<b>CS5</b>	Safety cable Ø1,5 mm L=300mm for front accessory with karabiner and quick link - SWL: 25 Kg	