

D'ARTAGNAN - 934SNX

900SNX - 2500 W HID



- **Type:** Profile spot
- **Source:** 2500 W HID
- **PSU:** Magnetic - hot restrike - DMX
- **Optics:** 16° to 38° zoom
- **DMX-control of motorised dimmer shutter and lamp ignition**

Profile spot

The one to call on when you need power!

The 2500 W D'Artagnan is the most powerful of profiles: indispensable for dramatic effects at the opera, ideal for outdoor TV recordings, fashion shows and large trade fair stands. It is the benchmark among profile spots for all large scale shows and can be seen in spectaculars across the world.

Features

- **Multi-function double gate:** simultaneous use of gobos and iris. Sharp focus of both gobo and shutter
- **Shutter gate:** up to 8 shutters. Remove shutters for easy maintenance or tuck fully inside gate for secure transport
- **User-friendly shutter-lock system:** secures shutters' setting in any circumstances (locking efficient up to 4 shutters)
- **Universal gobo holder:** "A" size glass and metal gobo
- **Lens tube lock feature:** secures rotating lens tube against unwanted movement
- **90° rotating lens tube / gate / front accessories holder:** rotation of the projected image is always possible while the lamp remains vertical – no need to move the yoke
- **Built-in motorised dimmer shutter:** perfect and smooth dimming control from 0 to 100% by DMX
- **Internal glass filter holder:** long term use of durable coloured, dichroic or textured glass
- **DMX remote controlled ignition**
- **Easy focus reference:** graduated scale on side of the unit; fast and easy refocusing
- **Tilt reference on hanging yoke:** index for rapid re-positioning

Optical

- **Factory set optical train:** no re-alignment even after lamp change
- **SX optical system:** double condenser optics for exceptional optical quality
- **Gobo :** excellent gobo projection
- **Variable zoom optics:** sharp focus at every beam angle. Independent control of image size and focus. Focus handles on both sides

Construction

- **Made in France :** fully manufactured in Robert Juliat premises retaining complete control over all aspects of quality
- **Separate PSU:** compact for easy handling and rapid maintenance
- **Silent-running cooling fans:** ideal for TV studios and opera houses
- **Bodywork:** strong sheet metal construction for durability
- **Moving parts:** smooth at all times, even when hot
- **Captive knobs and handles:** additional security when working at height or in transit
- **Easy access to all parts:** easy cleaning, re-lamping and maintenance
- **Removable assemblies:** fast-plug cable connectors and complete component assemblies (mirror, condenser set and lamp house assembly) save maintenance and cleaning time
- **Spare parts and accessories:** interchangeable across the tungsten, discharge or LED ranges, reducing running costs

Picture:934SNX

DSEN086_934SNX - 23/03/2022

Robert Juliat reserves the right to change or alter any of the items detailed on this page, to increase or improve manufacturing techniques without prior notice.

Robert Juliat S.A.S., 32 rue de Beaumont, 60530 Fresnoy-en-Thelle - France
Telephone : +33 (0)3 44 26 51 89 - fax : +33 (0)3 44 26 90 79 - info@robertjuliat.fr
www.robertjuliat.com



ROBERT JULIAT

Source



- **Lamp type:** Discharge
- **Power:** 2500 W
- **Socket:** G38
- **Hot re-strike:** yes

Admissible lamps	Power *	Lumen output*	Colour temperature*	Life*	CRI* (min)
CSR 2500W SEHR (GE)	2 500 W	220 000 lm	6000K	500 h	90
HMI 2500W/SE XS (Osram)	2 500 W	240 000 lm	6000K	500 h	90
MSR 2500W HR (Philips)	2 500 W	240 000 lm	6000K	500 h	95
USR 2500W HR (Ushio)	2 500 W	240 000 lm	5600K	500 h	80

(*) manufacturer's data

Optics

Characteristics

- **Type:** Zoom
- **Beam range:** 16° to 38°
- **Focal length:** 116 - 285 mm

Gel filter

- **Shape:** Square
- **Standard size:** 215x215 mm (8.5x8.5 in)

Gobo

- **Size:** A
- **Material:** Metal
Glass

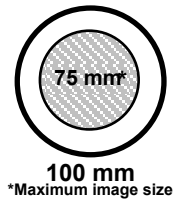

Photometrics

with MSR 2500W HR (Philips) source

• Optics @ 16°

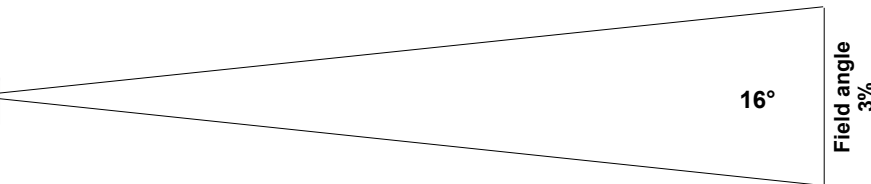
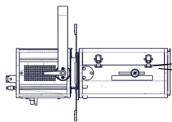

Beam intensity
450 000 cd

Distance	15 m	20 m	25 m	30 m	35 m	40 m
Diameter	4.2 m	5.6 m	7 m	8.4 m	9.8 m	11.2 m
Illumination	2 050 lux	1 150 lux	730 lux	510 lux	370 lux	290 lux
Distance	50 ft	65 ft	80 ft	100 ft	115 ft	130 ft
Diameter	14.1 ft	18.3 ft	22.5 ft	28.1 ft	32.3 ft	36.5 ft
Illumination	190 fc	110 fc	75 fc	46 fc	35 fc	27 fc

• Optics @ 38°

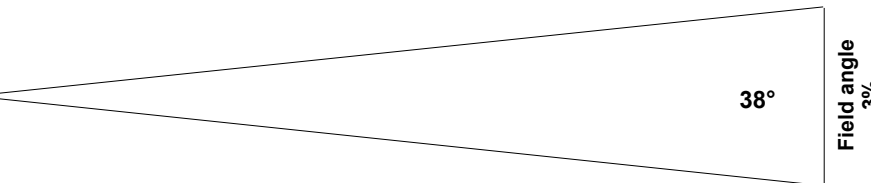
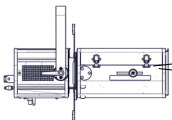

Beam intensity
99 000 cd

Distance	15 m	20 m	25 m	30 m	35 m	40 m
Diameter	10.3 m	13.8 m	17.2 m	20.7 m	24.1 m	27.5 m
Illumination	450 lux	250 lux	160 lux	120 lux	85 lux	65 lux
Distance	50 ft	65 ft	80 ft	100 ft	115 ft	130 ft
Diameter	34.4 ft	44.8 ft	55.1 ft	68.9 ft	79.2 ft	89.5 ft
Illumination	40 fc	24 fc	16 fc	10 fc	8 fc	6 fc

Remote control

- **Data protocol:** USITT DMX512-A

- **Data IN connector:** 5 pins XLR male
- **Data OUT connector:** 5 pins XLR femelle



• DMX chart:

Mode 1 (1 channels)

Dimmer

Mode 2 (2 channels)

Dimmer
Dimmer master

Mode 3 (2 channels)

Lamp
Dimmer

Mode 4 (3 channels)

Lamp
Dimmer
Dimmer master

Dimensions and weight

Unit

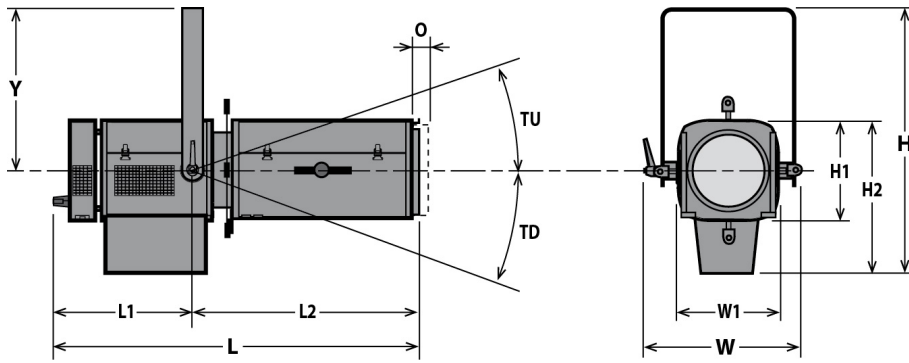

Weight: 30 kg (66 lbs)

Height	Length	Width	Yoke	Tilt	Option
H= 690 mm (27.2 in)	L= 870 mm (34.3 in)	W= 415 mm (16.3 in)	Y= 440 mm (17.3 in)	TU= 140°	O= 25 mm (1 in)
H1= 250 mm (9.8 in)	L1= TBD mm (0 in)	W1= 250 mm (9.8 in)		TD= 140°	TO= 60°
H2= 375 mm (14.8 in)	L2= TBD mm (0 in)				

Shipping

• **Weight :** 81 kg (178.2 lbs)

• **Volume :** .3 m³ (10.59 ft³)

PSU

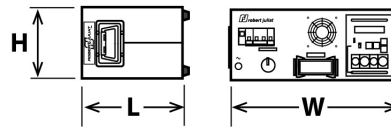

Width: W= 450 mm (17.7 in)

Height: H= 185 mm (7.3 in)

Length: L= 345 mm (13.6 in)

Weight: 34 Kg (74.8 lbs)

Installation

• **Minimum distance to illuminated surface:** 1.5 m (4.9 ft)

• **Operating position:**

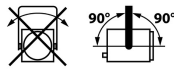

Warranty

• **Fixture: 2 years**

See General Sales Condition on website

Approvals



Construction

- **Housing:** Steel sheet - Aluminium
- **Colour:** Black
- **Cooling:** Low noise fan
- **Maximum ambient temperature (Ta):** 40°C (104°F)
- **Maximum case temperature (Tc):** 220°C (428°F)
- **Total heat dissipation:** 10 581 BTU/h
- **Ingress Protection (IP) rating:** IP20

- **PSU housing:** Steel sheet - Aluminium
- **PSU colour:** Black
- **PSU cooling:** Fans
- **PSU maximum ambient temperature (Ta):** 40°C (104°F)
- **PSU maximum case temperature (Tc):** 70°C (158°F)

Electrical compatibility

- 220/230 V - 50 Hz
- 245 V - 50 Hz
- ~~110/120 V - 60 Hz~~
- 208 V - 60 Hz
- ~~220/230 V - 60 Hz~~
- ~~100 V - 50 Hz~~
- ~~100 V - 60 Hz~~
- Selector: local switch

Power input



- **Type:** attached power cord
- **Cable:** HO7RNF 3G4
- **Length:** 3 m (9.8 ft)
- **Power connector:** 32A blue 2P+E 6h IEC60309 (CEE 32)

Power consumption

Voltage	Frequency	Current	Power	Power factor
230 V	50 Hz		3100 W	
208 V	60 Hz		3100 W	
245 V	50 Hz		3100 W	

Power Supply Unit

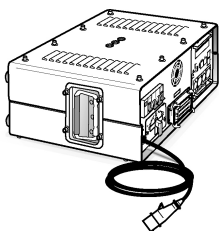



- **PSU:** Separate - Magnetic PSU
- **Lighting unit / PSU cable:** Removable cable - length: 3 m (9,8 ft)
Type: 18G1,5 H07RNF with 16x16A+E Harting Han® connectors
- **Maximum distance between lighting unit and PSU:** 25 m (82 ft)
- **Control:** Local / DMX
- **Protection:** Mains: 25A 2P2D - C curve breaker / Electronic: 1A 1P1D - C curve breaker / Auxiliary: 6A 2P2D - C curve breaker















Model

934SNX	2500 W HID Profile spot - 934SNX D'Artagnan - 16/38° - Magnetic PSU - DMX dimmer and lamp control
---------------	---

Options

CAV700	Double slot front cassette for 215x215mm accessories	
CAV700J	Double slot front cassette for 245x245mm accessories	

Accessories

D8	Shutter for SX series 4 included	
PF1000M2	215x215mm metal filter holder 1 included	
SGUX	Universal "A" size gobo-holder (metal, glass, frosted glass) 1 included	
VD120	120x120mm frosted glass 1 included	
MSR 2500W HR	MSR 2500W HR - Philips G38 2500W 500h 6000K lamp	
IWSX755	Drop-in iris (monoplane) with holder - Poids: 0.26 Kg	
G1000	215x215mm safety grid	
CAV700A	Double slot front cassette for 215x215mm accessories - Poids: 0.52 Kg	
CAV700AJ	Double slot front cassette for 245x245mm accessories - Poids: 0.95 Kg	
RV934	Front extension cassette for 215x215mm accessories with fan - Poids: 2 Kg	
FCD900SNX	Angled yoke - Poids: 1.7 Kg	
876	Hook clamp 40x10mm with 28mm M10 screw for Ø35 to 50mm pipes - SWL: 50Kg - Poids: 1.25 Kg	
880	Hook clamp 40x10mm with 28mm M10 screw for Ø50 to 63mm pipes - SWL: 50Kg - Poids: 1.36 Kg	
MLA	Mini yoke (with screws) - Poids: 0.9 Kg	

CS2

Safety cable Ø3 mm L= 600mm - SWL: 75 Kg

