

# GINGER - 1417

COMPACT - 2000/2500 W TUNGSTEN



- **Type:** Followspot
- **Source:** 2000/2500 W Tungsten
- **Optics:** 13° to 24° zoom

Followspot

## Television's tungsten favourite

The Ginger short throw tungsten followspot blends well with conventional theatre lighting and maintains the flat beam and constant colour temperature during dimming which is so important to sensitive camera equipment. Ideal for television studios, opera houses and ballets.

### Features

- **Fully closing iris cassette:** removable for fast, easy replacement; protective backplate for extended lifespan
- **Universal adjustable gobo holder:** "A" size glass and metal gobos
- **Ergonomic dimmer control:** one-handed dim, pan and tilt. Dimmer control can be adjusted to suit the operator's preference
- **Smooth dimmer shutter:** retains flat beam and colour temperature when dimming
- **Frost filter:** on flip lever for quick soft-edge beam effect
- **Horizontal chopper (optional):** for masking control in TV studios and wide stages
- **Internal glass filter holder:** long term use of durable coloured, dichroic or textured glass
- **Individually removable colour frame:** gels replaced easily while colour cassette remains in place
- **Colour changer:** 6-way, 'push/pull' colour changer system for simultaneous use of multiple filters
- **Easy focus reference:** graduated scale on side of the unit; fast and easy refocusing
- **Adjustable yoke (optional):** for optimum overhead positioning
- **Fine balance:** precision positioning and smooth operation even with the smallest movements
- **Stand:** perfectly weighted for maximum stability with smooth rotation for optimum performance. Easy set up; triple safety system for extra security

### Optical

- **Factory set optical train:** travels safely within followspot and requires no time-consuming realignment on arrival. Uniform beam on all followspots of same type
- **SX optical system:** double condenser optics for exceptional optical quality
- **Gobo :** excellent gobo projection
- **Variable zoom optics:** sharp focus at every beam angle. Independent control of image size and focus.

### Construction

- **Made in France :** fully manufactured in Robert Juliat premises retaining complete control over all aspects of quality
- **Local ON/OFF switch**
- **G22 socket locking system exclusive to Robert Juliat:** holds the lamp securely in place to ensure there is no arcing, even when the fixture is pointing vertically downward
- **Bodywork:** strong sheet metal construction for durability
- **Ergonomic wrap-around handle:** comfort, safety and practicality from all operating positions
- **Moving parts:** smooth at all times, even when hot
- **Captive knobs and handles:** additional security when working at height or in transit
- **Easy access to all parts:** easy cleaning, re-lamping and maintenance
- **Removable assemblies:** fast-plug cable connectors and complete component assemblies (mirror, condenser set and lamp house assembly) save maintenance and cleaning time

Picture:1417

DSEN109\_1417 - 08/11/2024

Robert Juliat reserves the right to change or alter any of the items detailed on this page, to increase or improve manufacturing techniques without prior notice.

Robert Juliat S.A.S., 32 rue de Beaumont, 60530 Fresnoy-en-Thelle - France  
Telephone : +33 (0)3 44 26 51 89 - info@robertjuliat.fr - www.robertjuliat.com



ROBERT JULIAT

## Source



- **Lamp type:** Tungsten
- **Socket:** G22

Admissible lamps	Power *	Lumen output*	Colour temperature*	Life*
LIF: CP92	2 000 W	52 000 lm	3200K	400 h
LIF: CP91	2 500 W	65 000 lm	3200K	400 h

(\*) manufacturer's data

## Optics

### Characteristics

- **Type:** Zoom
- **Range:** 13° to 24° (Field angle)
- **Focal length:** 169 - 316 mm

### Gel filter

- **Shape:** Circle
- **Standard size:** 210 mm (8.3 in)

### Gobo

- **Size:** A
- **Material:** Metal  
Glass



## Photometrics

optics: 13°-24° / Standard / LIF: CP91 2500W

### • Optics @ 13°

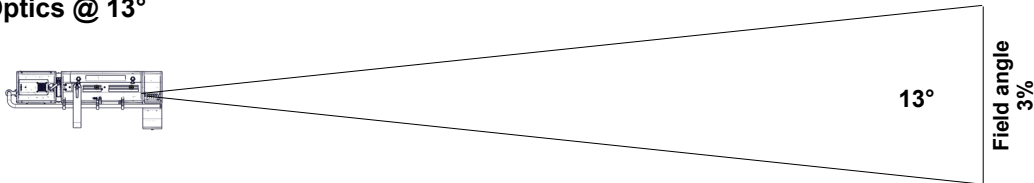

**Beam intensity**  
425 000 cd

<b>Distance</b>	5 m	10 m	15 m	20 m	25 m	30 m
<b>Diameter</b>	1.1 m	2.3 m	3.4 m	4.6 m	5.7 m	6.8 m
<b>Illumination</b>	17 500 lux	4 300 lux	1 900 lux	1 100 lux	690 lux	480 lux
<b>Distance</b>	15 ft	35 ft	50 ft	65 ft	80 ft	100 ft
<b>Diameter</b>	3.4 ft	8 ft	11.4 ft	14.8 ft	18.2 ft	22.8 ft
<b>Illumination</b>	1 900 fc	350 fc	180 fc	110 fc	70 fc	43 fc

### • Optics @ 24°

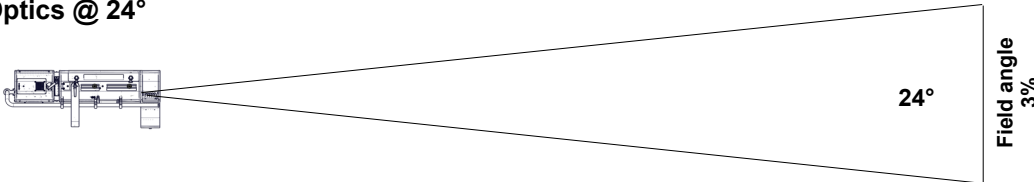

**Beam intensity**  
120 000 cd

<b>Distance</b>	5 m	10 m	15 m	20 m	25 m	30 m
<b>Diameter</b>	2.1 m	4.3 m	6.4 m	8.5 m	10.6 m	12.8 m
<b>Illumination</b>	4 850 lux	1 250 lux	540 lux	310 lux	200 lux	140 lux
<b>Distance</b>	15 ft	35 ft	50 ft	65 ft	80 ft	100 ft
<b>Diameter</b>	6.4 ft	14.9 ft	21.3 ft	27.6 ft	34 ft	42.5 ft
<b>Illumination</b>	540 fc	100 fc	49 fc	29 fc	19 fc	13 fc

## Dimensions and weight

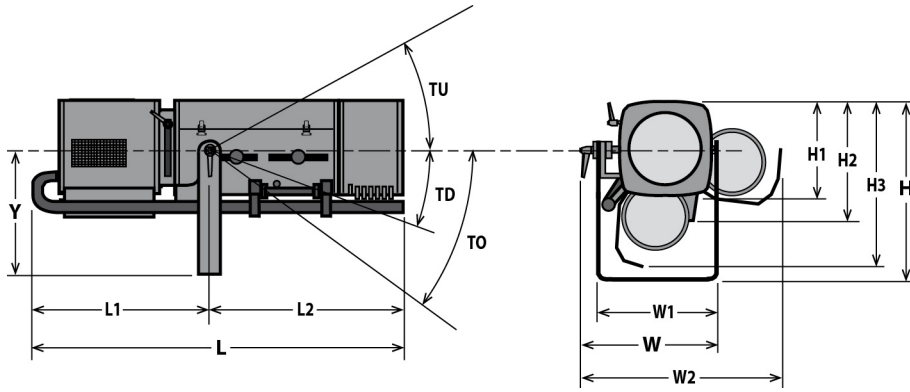

**Weight:** 29 kg (63.8 lbs)

Height	Length	Width	Yoke	Tilt	Option
H= 450 mm (17.7 in)	L= 900 mm (35.4 in)	W= 410 mm (16.1 in)	Y= 325 mm (12.8 in)	TU= 40°	TO= 70°
H1= 250 mm (9.8 in)	L1= 425 mm (16.7 in)	W1= 350 mm (13.8 in)		TD= 50°	
H2= 320 mm (12.6 in)	L2= 475 mm (18.7 in)	W2= 570 mm (22.4 in)			
H3= 460 mm (18.1 in)					

## Shipping

- **Weight :** 34 kg (74.8 lbs)
- **Volume :** .2 m<sup>3</sup> (7.06 ft<sup>3</sup>)

## Installation

- **Minimum distance to illuminated surface:** 2.8 m ( 9.2 ft )
- **Operating position:**

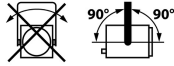

## Warranty

- **Fixture: 2 years**  
See General Sales Condition on website

## Approvals



## Construction

- **Housing:** Steel sheet - Aluminium
- **Colour:** Black
- **Cooling:** Low noise fan
- **Maximum ambient temperature (Ta):** 40°C (104°F)
- **Maximum case temperature (Tc):** 270°C (518°F)
- **Total heat dissipation:** 6 826 BTU/h
- **Ingress Protection (IP) rating:** IP20

## Electrical compatibility

- 230/240 V - 50 Hz
- ~~115/120 V - 60 Hz~~

## Power input



- **Type:** attached power cord
- **Cable:** H07RNF 3G1.5
- **Length:** 3 m (9.8 ft)
- **Power connector:** CEE 7/7 (2P+E NF/Schuko)







## Power consumption

Voltage	Frequency	Current	Power
230 V	50 Hz	9 A	2000 W
230 V	50 Hz	11 A	2500 W









## Model

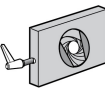





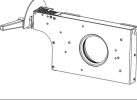











<b>1417</b>	2000/2500 W Tungsten Followspot - G22 socket - 1417 Ginger - 13/24°
-------------	---



## Options

<b>PCP1716A</b>	16A blue 2P+E 6h IEC60309 power connector	
<b>FRO/1117PV</b>	Heavy duty adjustable yoke	
<b>FRO/SMEPV</b>	Heavy duty adjustable yoke equipped with TILT SpotMe sensor (E type)	
<b>PG80</b>	Ø80mm chopper kit (G80+ GR120+ adaptation kit)	
<b>M210BM</b>	6 ways "boomerang" colour changer	
<b>FC1459</b>	Flight-case for Compact range / GT stand / P.S.U. / accessories - Dim: 1340x710x700mm - Weight: 55 Kg	

## Accessories

<b>CCU1</b>	Full closing iris cassette - Ø72mm - Weight: 1.33 Kg <b>1 included</b>	
<b>PF1011</b>	Ø210 mm metal filter holder <b>6 included</b>	
<b>SGUP2</b>	Universal "A" size gobo-holder (metal, glass, frosted glass) <b>1 included</b>	
<b>VDM100</b>	Ø97mm frosted glass with holder <b>1 included</b>	
<b>M210T</b>	6 ways "push/pull" colour changer - Weight: 3.67 Kg <b>1 included</b>	
<b>CP91</b>	CP91 - G22 2500W 230V 400h 3200K lamp	
<b>CP92</b>	CP92 - G22 2000W 230V 400h 3200K lamp	
<b>CCU1SM</b>	Full closing iris cassette with position sensor for SpotMe system - Ø72mm	
<b>GT1000</b>	Tripod stand - SWL: 40 Kg - max. height: 1550 mm - Weight: 9.27 Kg	
<b>GT4000</b>	Tripod stand with safety chain - SWL: 130 Kg - max. height: 1030 mm - Weight: 7.91 Kg	

<b>GT4000RSM</b>	Tripod stand with ball head rotation with security chain and SpotMe PAN sensor - SWL: 130 Kg - max. height: 1030 mm	
<b>GT4000S</b>	Tripod stand without safety chain - SWL: 130 Kg - max. height: 1030 mm - Weight: 8.65 Kg	
<b>JPP</b>	Monopod stand for overhead followspot - Weight: 3.6 Kg	
<b>T1000</b>	TV spigot with followspots swivel head - Weight: 1.82 Kg	
<b>T4000</b>	Followspot mount for Ø50mm pipe (suspension or overhead) - SWL= 100 Kg - Weight: 4.88 Kg	
<b>T4000RSM</b>	Followspot mount with ball head rotation and SpotMe PAN sensor - SWL = 100 Kg - Weight: 8.53 Kg	
<b>CAV700A</b>	Double slot front cassette for 215x215mm accessories - Weight: 0.52 Kg	
<b>FCM100R</b>	Ø97mm 1/2 CTO correction filter (Rosco #3408) with holder	
<b>VD120</b>	120x120mm frosted glass	
<b>FRO/1017PD</b>	Heavy duty adjustable yoke - Weight: 4.33 Kg	
<b>FRO/SMEPD</b>	Heavy duty adjustable yoke equipped with TILT SpotMe sensor (E type)	
<b>G80</b>	Ø80mm horizontal chopper - Weight: 0.37 Kg	
<b>GR120</b>	Slot reducer for SGUP gobo holder (if PG80 option ) - Weight: 0.2 Kg	
<b>Kit G80</b>	Ø80mm chopper kit (G80+ GR120+ adaptation kit) - Weight: 0.69 Kg	
<b>M210B</b>	6 ways "boomerang" colour changer - Weight: 3.36 Kg	
<b>M210TVCL</b>	Light shield for M210T push/pull colour changer - Weight: 1.98 Kg	
<b>BK/E1</b>	Extra weight kit for BK1 (0,5 Kg) - Weight: 0.5 Kg	
<b>BK1</b>	Followspot balancing kit (including 1 Kg counterweights) - Weight: 2.05 Kg	
<b>Kit TELRAD</b>	Telrad followspot sight with raiser and universal mounting kit - Weight: 1.23 Kg	

<b>SDUP</b>	Followspot cue sheet holder with universal mounting kit	
<b>TCSM</b>	SpotMe calibration tool kit	
<b>Maestro</b>	Maestro server for SpotMe - rackable unit: 1U - half 19" - Weight: 1.2 Kg	