

TIBO - 503

500 - 300/500 W TUNGSTEN



- **Type:** Profile spot
- **Source:** 300/500 W Tungsten
- **Optics:** 30° to 45° zoom
15° to 35° configuration possible

Profile spot

Brighter and Smaller

The TIBO Tungsten profile presents a compact and lightweight solution in a visionary, modern design. It features an outstanding unique optical design that allows two different zoom ranges (15°-35° and 30°-45°) in one single unit. TIBO fits aesthetically into any application, from architectural to event applications as well as traditional entertainment lighting.

Features

- **Shutter gate:** 4 shutters. Remove shutters for easy maintenance or tuck fully inside gate for secure transport
- **User-friendly shutter-lock system:** secures shutters' setting in any circumstances
- **Universal gobo holder:** m-size, glass and metal gobos
- **Continuous 360° rotation of the fixture:** adjustment of the projected image is always possible
- **Tilt reference on hanging yoke:** index for rapid re-positioning

Optical

- **Ellipsoidal reflector:** for efficient light output
- **Peak/flat adjustment:** ergonomic button to adjust light distribution
- **Variable zoom optics:** sharp focus at every beam angle. Independent control of image size and focus. Focus handles on both sides
- **Two different zoom ranges in one single unit:** 30/45° or 15/35° by adding/removing one lens - save on material costs and storage of separate lens tubes

Construction

- **Made in France :** fully manufactured in Robert Juliat premises retaining complete control over all aspects of quality
- **Air vents:** efficient cooling with no light spill
- **Bodywork:** die cast aluminium housing
- **Captive knobs and handles:** additional security when working at height or in transit
- **Spare parts and accessories:** uniform across the tungsten, LED or HID TIBO range, reducing running costs
- **Easy access to lens tube without tool:** easy cleaning of zoom lenses
- **Secured lamp change without tool:** automatic electrical disconnection of the lamp base through 2 safety switches (neutral and phase)

Picture:503

DSEN180_503 - 02/10/2018

Robert Juliat reserves the right to change or alter any of the items detailed on this page, to increase or improve manufacturing techniques without prior notice.

Robert Juliat S.A.S., 32 rue de Beaumont, 60530 Fresnoy-en-Thelle - France
Telephone : +33 (0)3 44 26 51 89 - fax : +33 (0)3 44 26 90 79 - info@robertjuliat.fr
www.robertjuliat.com



ROBERT JULIAT

Source



- **Lamp type:** Tungsten
- **Socket:** Gy9.5

Admissible lamps	Power *	Lumen output*	Colour temperature*	Life*
LIF: CP81	300 W	7 500 lm	3200K	200 h
LIF: CP82	500 W	13 500 lm	3200K	200 h
LIF: M40	500 W	8 500 lm	2900K	2 000 h

(*) manufacturer's data

Optics

Characteristics

- **Type:** Zoom
- **Beam range:** 30° to 45°
15° to 35° configuration possible
- **Focal length:** 68 - 105 mm

Gel filter

- **Shape:** Square
- **Standard size:** 138x138 mm (5.4x5.4 in)

Gobo

- **Size:** M
- **Material:** Metal
Glass



Photometrics

with LIF: CP82 source

• Optics @ 30°

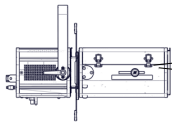

Distance	3 m	5 m	7 m	10 m	12 m	15 m
Diameter	1.5 m	2.5 m	3.5 m	5 m	6.1 m	7.6 m
Illumination	10 500 lux	3 800 lux	1 950 lux	940 lux	660 lux	420 lux
Distance	10 ft	15 ft	25 ft	35 ft	40 ft	50 ft
Diameter	5 ft	7.6 ft	12.6 ft	17.6 ft	20.2 ft	25.2 ft
Illumination	940 fc	420 fc	160 fc	80 fc	60 fc	38 fc

Beam intensity
93 900 cd

Field lumens
5 760 lm

Efficacy
12 lm/W

CCT
3 150 K

• Optics @ 45°

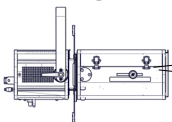

Distance	3 m	5 m	7 m	10 m	12 m	15 m
Diameter	2.5 m	4.1 m	5.8 m	8.2 m	9.9 m	12.3 m
Illumination	7 100 lux	2 550 lux	1 300 lux	640 lux	440 lux	290 lux
Distance	10 ft	15 ft	25 ft	35 ft	40 ft	50 ft
Diameter	8.2 ft	12.3 ft	20.6 ft	28.8 ft	32.9 ft	41.1 ft
Illumination	640 fc	290 fc	110 fc	55 fc	40 fc	26 fc

Beam intensity
63 300 cd

CCT
3 130 K

Dimensions and weight

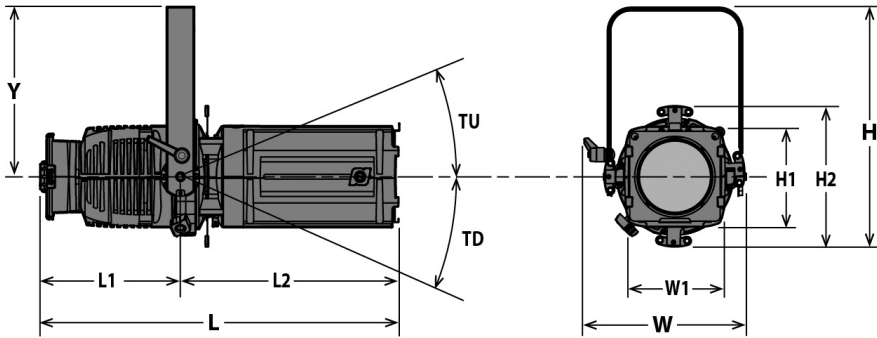

Weight: 6.9 kg (15.2 lbs)

Height	Length	Width	Yoke	Tilt
H= 363 mm (14.3 in)	L= 536 mm (21.1 in)	W= 251 mm (9.9 in)	Y= 252 mm (9.9 in)	TU= 67°
H1= 150 mm (5.9 in)	L1= 210 mm (8.3 in)	W1= 150 mm (5.9 in)		TD= 90°
H2= 226 mm (8.9 in)	L2= 326 mm (12.8 in)			

Shipping

- **Weight :** 8.5 kg (18.7 lbs)
- **Volume :** .05 m³ (1.77 ft³)

Installation

- **Minimum distance to illuminated surface:** 1.8 m (5.9 ft)
- **Operating position:**

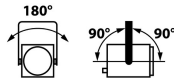

Construction

- **Housing:** Die cast aluminium
- **Colour:** Black
- **Cooling:** Convection cooling
- **Maximum ambient temperature (Ta):** 40°C (104°F)
- **Maximum case temperature (Tc):** 170°C (338°F)
- **Total heat dissipation:** 1 024 BTU/h
- **Protection rating:** 20

Electrical compatibility

- 230/240 V - 50 Hz
- ~~415/420 V - 60 Hz~~

Power input



- **Type:** attached power cord
- **Cable:** HT Silicon 3G1
- **Length:** 1,5 m (4,9 ft)
- **Power connector:** without connector

Power consumption

Voltage	Frequency	Current	Power
230 V	50 Hz	1.3 A	300 W
230 V	50 Hz	2.2 A	500 W

Approvals

Warranty

- **Period: 2 years**
See General Sales Condition on website









Model

503	300/500 W Tungsten Profile spot - Gy9.5 socket - 503 Tibo - 30/45°
------------	--

Options

PCP1716A	16A blue 2P+E 6h IEC60309 power connector	
-----------------	---	---

Accessories

D4	Shutter for Tibo series 4 included	
PF100M	135x135mm metal filter holder 1 included	
CP82	CP82 - Gy9.5 500W 230V 200h 3200K lamp	
IS500	Drop-in iris (monoplane) with holder	
SGUT	Universal "M" size gobo-holder (metal, glass, frosted glass)	
872	Doughty "Twenty clamp" with M10 screw/nut for Ø48 to 51mm pipes - SWL: 20Kg - TÜV approved - Weight: ,25 Kg	
878	Hook clamp 25x6mm with 23mm M10 screw for Ø35 to 50mm pipes - SWL: 11Kg - Weight: ,46 Kg	
CS2	Safety cable Ø3 mm L= 600mm - SWL: 75 Kg	