

TIBO - 523

500 - HID 250 W



- **Type:** Profile spot
- **Source:** HID 250 W
- **PSU:** Electronic
- **Optics:** 30° to 45° zoom
15° to 35° configuration possible

Profile spot

Brighter and Smaller

Tibo HID is a completely new tool for lighting professionals. Its CDM-T 250 W discharge source is extremely powerful yet housed in a very compact body. It presents a cost-effective lighting solution offering good value for money of its long lamp life and lower maintenance costs. Tibo HID is ideal for the projection of static images, architectural applications and showcasing buildings. For applications which require intense, non-dimmable light output, the 523 is the unbeatable, powerful solution.

Features

- **Shutter gate:** 4 shutters. Remove shutters for easy maintenance or tuck fully inside gate for secure transport
- **User-friendly shutter-lock system:** secures shutters' setting in any circumstances
- **Universal gobo holder:** m-size, glass and metal gobos
- **Continuous 360° rotation of the fixture:** adjustment of the projected image is always possible
- **Tilt reference on hanging yoke:** index for rapid re-positioning

Optical

- **Long lamp life (8000 h)**
- **Choice of colour temperatures:** 3000K and 4200K
- **Ellipsoidal reflector:** for efficient light output
- **Variable zoom optics:** sharp focus at every beam angle. Independent control of image size and focus. Focus handles on both sides
- **Two different zoom ranges in one single unit:** 30/45° or 15/35° by adding/removing one lens - save on material costs and storage of separate lens tubes

Construction

- **Made in France :** fully manufactured in Robert Juliat premises retaining complete control over all aspects of quality
- **Separate electronic flicker-free PSU:** can be separate or on yoke
- **Air vents:** efficient cooling with no light spill
- **Bodywork:** die cast aluminium housing
- **Captive knobs and handles:** additional security when working at height or in transit
- **Spare parts and accessories:** uniform across the tungsten, LED or HID TIBO range, reducing running costs
- **Easy access to lens tube without tool:** easy cleaning of zoom lenses
- **Automatic disconnection:** acces to the lamp secured by 2 safety switches

Picture:523

DSEN208_523 - 02/10/2018

Robert Juliat reserves the right to change or alter any of the items detailed on this page, to increase or improve manufacturing techniques without prior notice.

Robert Juliat S.A.S., 32 rue de Beaumont, 60530 Fresnoy-en-Thelle - France
Telephone : +33 (0)3 44 26 51 89 - fax : +33 (0)3 44 26 90 79 - info@robertjuliat.fr
www.robertjuliat.com



ROBERT JULIAT

Source

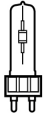

- **Lamp type:** Discharge
- **Power:** 250 W
- **Socket:** G12
- **Hot re-strike:** no

Admissible lamps	Power *	Lumen output*	Colour temperature*	Life*	CRI* (min)
CDM-T 250W 830 (Philips)	250 W	23 000 lm	3000K	8 000 h	89
CDM-T 250W 942 (Philips)	250 W	23 300 lm	4200K	8 000 h	94

(*) manufacturer's data

Optics

Characteristics

- **Type:** Zoom
- **Beam range:** 30° to 45°
15° to 35° configuration possible
- **Focal length:** 68 - 105 mm

Gel filter

- **Shape:** Square
- **Standard size:** 138x138 mm (5.4x5.4 in)

Gobo

- **Size:** M
- **Material:** Metal
Glass

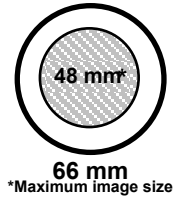

Photometrics

with CDM-T 250W 942 (Philips) source

• Optics @ 30°

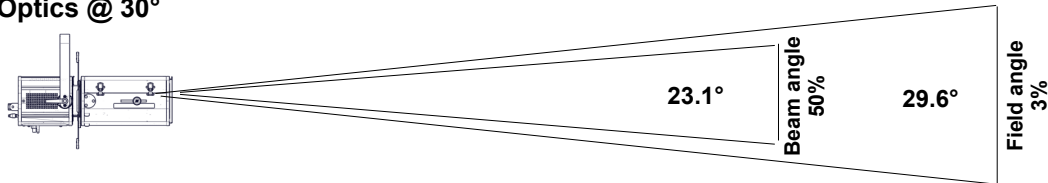

Beam intensity
51 700 cd

Field lumens
6 560 lm

Efficacy
26 lm/W

CCT
3 790 K

Distance	3 m	5 m	7 m	10 m	12 m	15 m
Diameter	1.6 m	2.6 m	3.7 m	5.3 m	6.3 m	7.9 m
Illumination	5 800 lux	2 100 lux	1 100 lux	520 lux	360 lux	230 lux
Distance	10 ft	15 ft	25 ft	35 ft	40 ft	50 ft
Diameter	5.3 ft	7.9 ft	13.2 ft	18.5 ft	21.1 ft	26.4 ft
Illumination	520 fc	230 fc	85 fc	43 fc	33 fc	21 fc

• Optics @ 45°

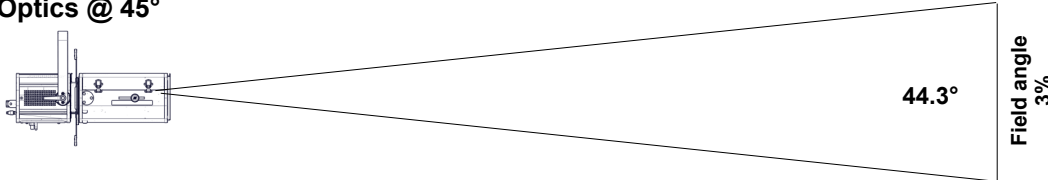

Beam intensity
36 800 cd

CCT
3 750 K

Distance	3 m	5 m	7 m	10 m	12 m	15 m
Diameter	2.4 m	4.1 m	5.7 m	8.1 m	9.8 m	12.2 m
Illumination	4 100 lux	1 500 lux	760 lux	370 lux	260 lux	170 lux
Distance	10 ft	15 ft	25 ft	35 ft	40 ft	50 ft
Diameter	8.1 ft	12.2 ft	20.4 ft	28.5 ft	32.6 ft	40.7 ft
Illumination	370 fc	170 fc	60 fc	31 fc	24 fc	15 fc

Dimensions and weight

Unit

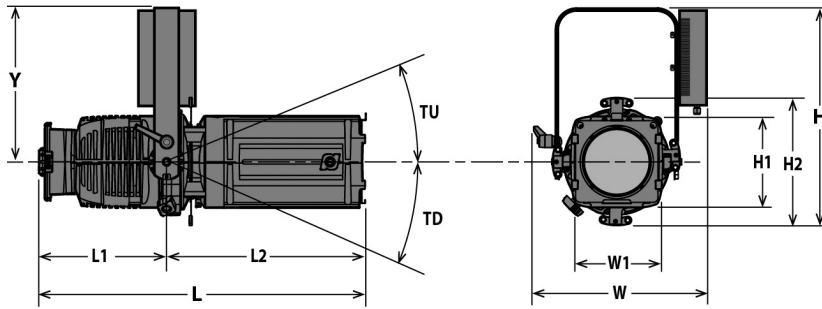

Weight: 8.9 kg (19.6 lbs)
with PSU

Height	Length	Width	Yoke	Tilt
H= 363 mm (14.3 in)	L= 526 mm (20.7 in)	W= 309 mm (12.2 in)	Y= 252 mm (9.9 in)	TD= 90°
H1= 150 mm (5.9 in)	L1= 200 mm (7.9 in)	W1= 150 mm (5.9 in)		
H2= 226 mm (8.9 in)	L2= 326 mm (12.8 in)	W2= 245 mm (9.6 in)		

Shipping

• **Weight :** Unit: 8.5 kg (5.1 lbs)
PSU: 2.3 kg (5.1 lbs)

• **Volume :** Unit: .05 m³ (1.77 ft³)
PSU: .01 m³ (.28 ft³)

PSU

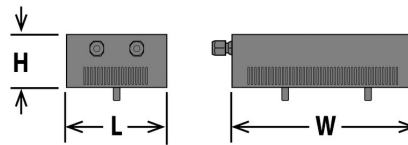

Width: W= 210 mm (8.3 in)

Height: H= 64 mm (2.5 in)

Length: L= 130 mm (5.1 in)

Weight: 2 Kg (4.4 lbs)

Installation

• **Minimum distance to illuminated surface:** 0.8 m (2.6 ft)

• **Operating position:**

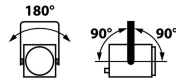

Warranty

• **Period: 2 years**
See General Sales Condition on website

Approvals



Construction

- **Housing:** Die cast aluminium
- **Colour:** Black
- **Cooling:** Convection cooling
- **Maximum ambient temperature (Ta):** 40°C (104°F)
- **Maximum case temperature (Tc):** 110°C (230°F)
- **Total heat dissipation:** 853 BTU/h
- **Protection rating:** 20

- **PSU housing:** Steel sheet - Aluminium
- **PSU colour:** Black
- **PSU cooling:** Convection cooling
- **PSU maximum ambient temperature (Ta):** 50°C (122°F)
- **PSU maximum case temperature (Tc):** °C (°F)

Electrical compatibility

- 220/230 V - 50 Hz
- 245 V - 50 Hz
- ~~110/120 V - 60 Hz~~
- 208 V - 60 Hz
- 220/230 V - 60 Hz
- ~~100 V - 50 Hz~~
- ~~100 V - 60 Hz~~
- Selector: automatic detection

Power input



- **Type:** attached power cord
- **Cable:** H07RNF 3G1.5
- **Length:** 1,5 m (4,9 ft)
- **Power connector:** CEE 7/7 (2P+E NF/Schuko)

Power consumption

Voltage	Frequency	Current	Power	Power factor
230 V	50 Hz	1.2 A	250 W	0,98

Power Supply Unit

- **PSU:** On yoke - Electronic PSU - Flicker free with PFC
- **Lighting unit / PSU cable:** Not removable - length: 1,5 m (4,9 ft)
Type: 3G1 Silicone HT
- **Maximum distance between lighting unit and PSU:** 2 m (7 ft)
- **Control:**
- **Protection:** -









Model

523	HID 250 W Profile spot - 523 Tibo - 30/45° - Electronic PSU
------------	---

Options

PCP1716A	16A blue 2P+E 6h IEC60309 power connector	
-----------------	---	---

Accessories

D4	Shutter for Tibo series 4 included	
PF100M	135x135mm metal filter holder 1 included	
CDM-T 250W 830	CDM-T 250W 830 - Philips G12 250W 8000h 3000K lamp	
CDM-T 250W 942	CDM-T 250W 942 - Philips G12 250W 8000h 4200K lamp	
IS500	Drop-in iris (monoplane) with holder	
SGUT	Universal "M" size gobo-holder (metal, glass, frosted glass)	
872	Doughty "Twenty clamp" with M10 screw/nut for Ø48 to 51mm pipes - SWL: 20Kg - TÜV approved - Weight: ,25 Kg	
878	Hook clamp 25x6mm with 23mm M10 screw for Ø35 to 50mm pipes - SWL: 11Kg - Weight: ,46 Kg	
CS2	Safety cable Ø3 mm L= 600mm - SWL: 75 Kg	