

SULLY - 1156CW

ULTRA COMPACT - LED 115 W



- **Type:** Followspot
- **Source:** LED 115 W
- **Optics:** 10.5° to 22.5° zoom
- **Colour temperature:** Cool White

Followspot

An affordable entry point LED followspot with no compromise on quality

Sully 1156 is the perfect introduction to Robert Juliat LED followspots for discerning schools, amateur dramatics and smaller venues. Its optical excellence, ultra compact dimensions and low power consumption make it a reliable and easy to use luminaire. Sully features a high-quality 115 W cool white LED source that delivers a first-class white light and an output that exceeds a 2500 W tungsten luminaire equipped with CTB filter. Controlled both locally and remotely by DMX, this little followspot is definitely accessible to beginners as well as skilled operators.

Features

- **Fully closing iris:** removable for fast, easy replacement
- **Universal gobo holder:** "A" size glass and metal gobo
- **Local control:** light intensity adjustment through built-in potentiometer
- **Internal glass filter holder:** long term use of durable coloured, dichroic or textured glass
- **Colour changer:** 6-way, 'push/pull' colour changer system for simultaneous use of multiple filters
- **Adjustable response time:** choice of fast or slow dimming for tungsten-like simulation - adjustment by DMX protocol
- **Universal data control:** compatible with DMX, RDM, Art-Net, sACN protocols
- **Remote setup:** all parameters can be adjusted by RDM protocol or by web interface
- **PWM adjustment:** choice of different PWM dimming frequencies - continuous mode available
- **Dimming parameters:** choice of square or linear dimming curves
- **Local setup (optional):** DMX address and mode, dimming curve and response time through 4-button display with automatic light switch-off
- **DMX:** 8 or 16 bit dimming, response time and strobe function
- **Easy focus reference:** graduated scale on side of the unit; fast and easy refocusing

Optical

- **Long life:** outstanding operational lifetime expectation, no need to replace lamps, low maintenance
- **Choice of colour temperature:** warm or cool white LED compartment can be easily swapped
- **SX optical system:** double condenser optics for exceptional optical quality
- **Optional coated double condenser optics:** up to 15% more light output
- **Variable zoom optics:** sharp focus at every beam angle. Independent control of image size and focus. Focus handles on both sides
- **Electronic dimmer:** dimming without clipping or cut-out at low intensity levels; high quality smoothing
- **No colour shift:** colour temperature remains the same when dimming

Construction

- **Made in France :** fully manufactured in Robert Juliat premises retaining complete control over all aspects of quality
- **Interchangeable lamp bases:** with 600SX (1000/1200 W tungsten) series
- **PSU:** built-in electronic flicker-free power supply for easy, plug-and-play installation
- **Power connectors:** compatible powerCON® TRUE1 IN and OUT connectors for daisy chaining
- **Silent-running cooling fans:** ideal for TV studios and opera houses
- **Electronic thermal management system:** ensures maximum performance of the system without any risk of overheating
- **Bodywork:** strong sheet metal construction for durability
- **Captive knobs and handles:** additional security when working at height or in transit
- **Easy access to all parts:** easy cleaning and maintenance

Picture:1156

DSEN390_1156CW - 03/04/2025

Robert Juliat reserves the right to change or alter any of the items detailed on this page, to increase or improve manufacturing techniques without prior notice.

Robert Juliat S.A.S., 32 rue de Beaumont, 60530 Fresnoy-en-Thelle - France
Telephone : +33 (0)3 44 26 51 89 - info@robertjuliat.fr - www.robertjuliat.com



ROBERT JULIAT



- Lamp type: LED
- Power: 115 W

LED specifications	Power *	Lumen output*	Colour temperature*	CRI*
LED 115W CW	115 W	14 300 lm	5700K	93

(*) manufacturer's data

Optics

Characteristics

- Type: Zoom
- Range: 10.5° to 22.5° (Field angle)
- Focal length: - mm

Gel filter

- Shape: Circle
- Standard size: 165 mm (6.5 in)

Gobo

- Size: A
- Material: Metal
Glass

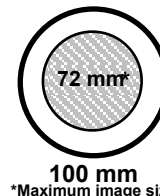

Photometrics (Photometrics report(s) available at the end of the document)

optics: 10,5°-22,5° / Standard

• Optics @ 10.5°

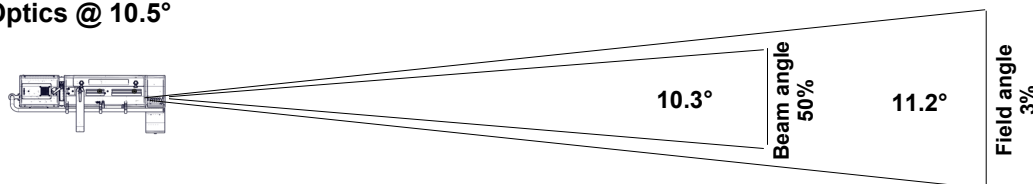

Beam intensity
275 300 cd

Field lumens
5 450 lm

Efficacy
37 lm/W

Distance	5 m	10 m	15 m	20 m	25 m	30 m
Diameter	1 m	2 m	2.9 m	3.9 m	4.9 m	5.9 m
Illumination	11 500 lux	2 800 lux	1 250 lux	690 lux	450 lux	310 lux
Distance	15 ft	35 ft	50 ft	65 ft	80 ft	100 ft
Diameter	2.9 ft	6.9 ft	9.8 ft	12.7 ft	15.7 ft	19.6 ft
Illumination	1 250 fc	230 fc	120 fc	70 fc	44 fc	28 fc

• Optics @ 22.5°

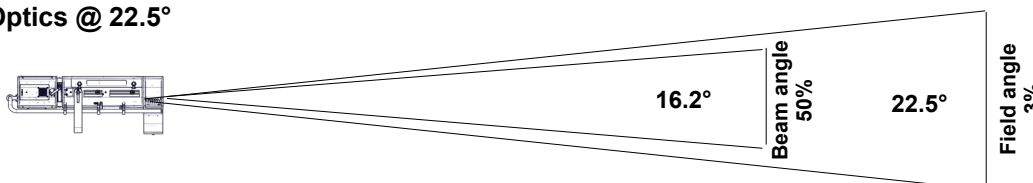

Beam intensity
75 900 cd

Field lumens
5 130 lm

Efficacy
25 lm/W

Distance	5 m	10 m	15 m	20 m	25 m	30 m
Diameter	2 m	4 m	6 m	8 m	9.9 m	11.9 m
Illumination	3 050 lux	760 lux	340 lux	190 lux	130 lux	85 lux
Distance	15 ft	35 ft	50 ft	65 ft	80 ft	100 ft
Diameter	6 ft	13.9 ft	19.9 ft	25.9 ft	31.8 ft	39.8 ft
Illumination	340 fc	65 fc	31 fc	18 fc	12 fc	8 fc

Remote control

- Data protocol: USITT DMX512-A
RDM / Art-Net / sACN

- Data IN connector: 5 pins XLR male +
2x etherCON RJ45
- Data OUT connector 5 pins XLR female



• DMX chart:

Mode 1 (1 channels)	Mode 2 (2 channels)	Mode 3 (5 channels)	Mode 4 (6 channels)	Mode 5 (6 channels)	Mode 6 (8 channels)
Dimmer	Dimmer Dimmer fine	Dimmer Strobe duration Strobe speed Response time Control mode	Dimmer Dimmer fine Strobe duration Strobe speed Response time Control mode	Dimmer Master dimmer Strobe duration Strobe speed Response time Control mode	Dimmer Dimmer fine Master dimmer Master dimmer fine Strobe duration Strobe speed Response time Control mode

Dimensions and weight

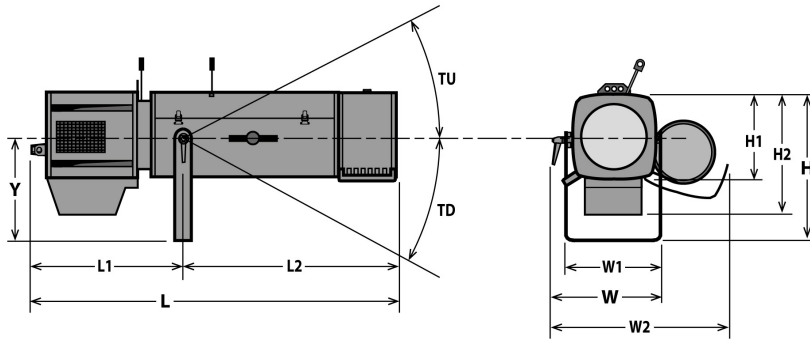

Weight: 15.6 kg (34.3 lbs)

Height	Length	Width	Yoke	Tilt
H= 387 mm (15.2 in)	L= 928 mm (36.5 in)	W= 327 mm (12.9 in)	Y= 283 mm (11.1 in)	TU= 38°
H1= 208 mm (8.2 in)	L1= 411 mm (16.2 in)	W1= 233 mm (9.2 in)		TD= 56°
H2= 284 mm (11.2 in)	L2= 517 mm (20.4 in)	W2= 472 mm (18.6 in)		

Shipping

- **Weight :** 18.8 kg (41.4 lbs)
- **Volume :** .16 m³ (5.65 ft³)

Installation

- **Minimum distance to illuminated surface:** 0.8 m (2.6 ft)
- **Operating position:**



Construction

- **Housing:** Steel sheet - Aluminium
- **Colour:** Black
- **Cooling:** Low noise variable fan
- **Maximum ambient temperature (Ta):** 40°C (104°F)
- **Maximum case temperature (Tc):** 52°C (125.6°F)
- **Total heat dissipation:** 444 BTU/h
- **Ingress Protection (IP) rating:** IP20

Electrical compatibility

- 220/230 V - 50 Hz
- 245 V - 50 Hz
- 110/120 V - 60 Hz
- 208 V - 60 Hz
- 220/230 V - 60 Hz
- 100 V - 50 Hz
- 100 V - 60 Hz
- Selector: automatic detection

Power input



- **Type:** removable power cord with compatible powerCON® TRUE1 connector (included)
- **Cable:** H07RNF 3G1.5
- **Length:** 3 m (9.8 ft)
- **Power connector:** CEE 7/7 (2P+E NF/Schuko)

Power consumption

Voltage	Frequency	Current	Power	Power factor
230 V	50 Hz	0.7 A	130 W	0.81
120 V	60 Hz	1.15 A	135 W	0.98
100 V	60 Hz	1.4 A	135 W	0.96

Power Supply Unit

- **PSU:** Internal - Electronic PSU - Flicker free with PFC
- **Control:** Local / DMX
- **Protection:** Mains: 2x 6.3A 5x20 T fuses /
- **Power thru:** compatible powerCON® TRUE1 - Maximum of 22 units (230 V) / 11 units (120 V)

Warranty

- **Fixture: 3 years - Source: 5 years**
See General Sales Condition on website

Approvals







Acoustics

- **Noise level:** < 22,8 dB(A)



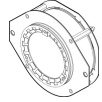







Model





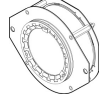

1156CW	LED 115 W Followspot - 1156CW Sully - Cool White - 10.5/22.5°
---------------	---

Options

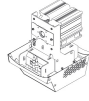
APH 68LEDM	Double-condenser set for Led profile	
PCP1716A	16A blue 2P+E 6h IEC60309 power connector	
DISP2	Display and keyboard for local setup	
FC1124	Flight-case for Ultra Compact range / GT stand - Dim: 1210x600x560mm - Weight: 35 Kg	

Accessories

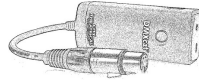
IS750	Full closing iris with holder - Weight: 0.35 Kg 1 included	
PF1114	Ø165 mm metal filter holder 6 included	
SGUX	Universal "A" size gobo-holder (metal, glass, frosted glass) 1 included	
M165TP	6 ways "push/pull" colour changer - Weight: 2.09 Kg 1 included	
GT1000	Tripod stand - SWL: 40 Kg - max. height: 1550 mm - Weight: 9.27 Kg	
GT800	Tripod stand - SWL: 40 Kg - max. height: 1550 mm - Weight: 7.98 Kg	
T1000	TV spigot with followspots swivel head - Weight: 1.82 Kg	
T4000	Followspot mount for Ø50mm pipe (suspension or overhead) - SWL= 100 Kg - Weight: 4.88 Kg	
CAV600A	Double slot front cassette for 180x180mm accessories - Weight: 0.43 Kg	
APH 68LED	Double-condenser set for Led profile - Weight: 0.58 Kg	
T/1650DSXCW	SULLY 115W LED compartment with potentiometer and display - Cool White - 3 meter power cable with CEE 7/7 (2P+T NF/SCHUKO) connector - Weight: 2.33 Kg	
T/1650DSXWW	SULLY 115W LED compartment with potentiometer and display - Warm White - 3 meter power cable with CEE 7/7 (2P+T NF/SCHUKO) connector - Weight: 2.33 Kg	

T/1650SXWW	SULLY 115W LED compartment with potentiometer - Warm White - 3 meter power cable with CEE 7/7 (2P+T NF/SCHUKO) connector - Weight: 2.27 Kg	
VD120	120x120mm frosted glass	
Kit TELRAD	Telrad followspot sight with raiser and universal mounting kit - Weight: 1.23 Kg	
SDUP	Followspot cue sheet holder with universal mounting kit	
DMXcat	Bluetooth DMX/RDM Multifunction test tool - City Theatrical DMXcat®	
FC1124/S	Flight-case for Ultra Compact range / GT stand - Weight: 35 Kg	
W/GT800	Set of 3 wheels for GT800/1000 stand - Weight: 2.33 Kg	

• Optics @ 10,5°

Field lumens	Beam lumens	Efficacy	Beam intensity	CCT	Delta uv
5 450 Lm	4 890 Lm	37 Lm/W	275 300 Cd	5 490 K	0.0004

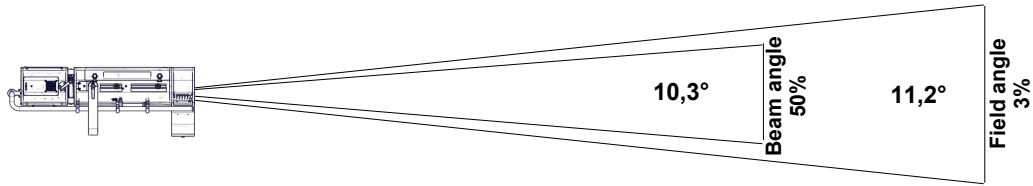

Distance	5 m	10 m	15 m	20 m	25 m	30 m
Field diameter	1 m	2 m	2,9 m	3,9 m	4,9 m	5,9 m
Illumination	11 500 lux	2 800 lux	1 250 lux	690 lux	450 lux	310 lux
Distance	15 ft	35 ft	50 ft	65 ft	80 ft	100 ft
Field diameter	2,9 ft	6,9 ft	9,8 ft	12,7 ft	15,7 ft	19,6 ft
Illumination	1 250 fc	230 fc	120 fc	70 fc	44 fc	28 fc

• Optics @ 16,5°

Field lumens	Beam lumens	Efficacy	Beam intensity	CCT	Delta uv
5 480 Lm	4 050 Lm	37 Lm/W	156 400 Cd	5 410 K	0.0004

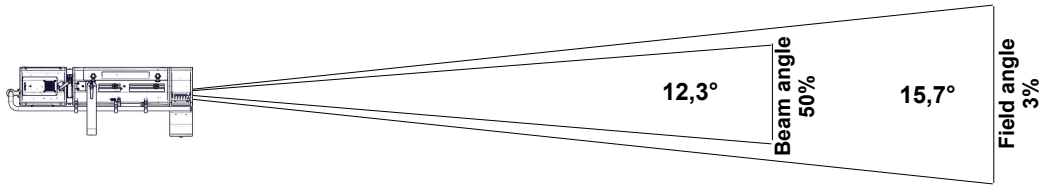

Distance	5 m	10 m	15 m	20 m	25 m	30 m
Field diameter	1,4 m	2,8 m	4,1 m	5,5 m	6,9 m	8,3 m
Illumination	6 300 lux	1 600 lux	700 lux	400 lux	260 lux	180 lux
Distance	15 ft	35 ft	50 ft	65 ft	80 ft	100 ft
Field diameter	4,1 ft	9,7 ft	13,8 ft	17,9 ft	22,1 ft	27,6 ft
Illumination	700 fc	130 fc	65 fc	38 fc	25 fc	16 fc

• Optics @ 22,5°

Field lumens	Beam lumens	Efficacy	Beam intensity	CCT	Delta uv
5 130 Lm	3 380 Lm	25 Lm/W	75 900 Cd	5 360 K	0.0004

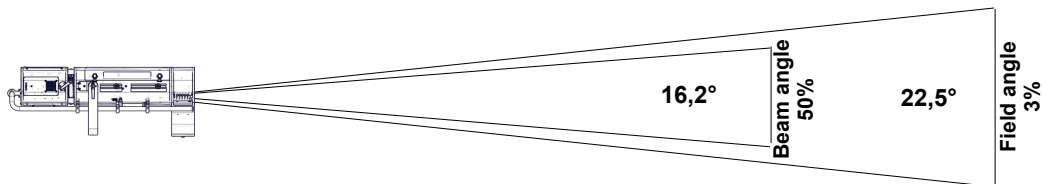

Distance	5 m	10 m	15 m	20 m	25 m	30 m
Field diameter	2 m	4 m	6 m	8 m	9,9 m	11,9 m
Illumination	3 050 lux	760 lux	340 lux	190 lux	130 lux	85 lux
Distance	15 ft	35 ft	50 ft	65 ft	80 ft	100 ft
Field diameter	6 ft	13,9 ft	19,9 ft	25,9 ft	31,8 ft	39,8 ft
Illumination	340 fc	65 fc	31 fc	18 fc	12 fc	8 fc

• Optics @ 10,5°

Field lumens	Beam lumens	Efficacy	Beam intensity	CCT	Delta uv
6 340 Lm	5 630 Lm	49 Lm/W	319 000 Cd	5 400 K	

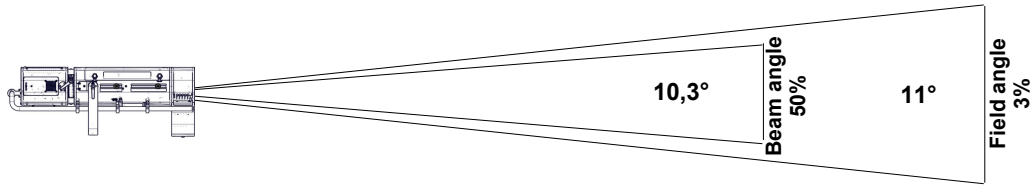

Distance	5 m	10 m	15 m	20 m	25 m	30 m
Field diameter	1 m	1,9 m	2,9 m	3,9 m	4,8 m	5,8 m
Illumination	13 000 lux	3 200 lux	1 450 lux	800 lux	520 lux	360 lux
Distance	15 ft	35 ft	50 ft	65 ft	80 ft	100 ft
Field diameter	2,9 ft	6,7 ft	9,6 ft	12,5 ft	15,4 ft	19,3 ft
Illumination	1 450 fc	270 fc	130 fc	80 fc	50 fc	32 fc

• Optics @ 16,5°

Field lumens	Beam lumens	Efficacy	Beam intensity	CCT	Delta uv
6 370 Lm	5 670 Lm	49 Lm/W	178 700 Cd	5 340 K	

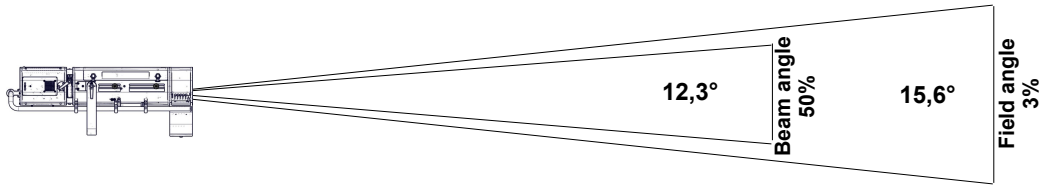

Distance	5 m	10 m	15 m	20 m	25 m	30 m
Field diameter	1,4 m	2,7 m	4,1 m	5,5 m	6,8 m	8,2 m
Illumination	7 200 lux	1 800 lux	800 lux	450 lux	290 lux	200 lux
Distance	15 ft	35 ft	50 ft	65 ft	80 ft	100 ft
Field diameter	4,1 ft	9,6 ft	13,7 ft	17,8 ft	21,9 ft	27,4 ft
Illumination	800 fc	150 fc	75 fc	43 fc	28 fc	18 fc

• Optics @ 22,5°

Field lumens	Beam lumens	Efficacy	Beam intensity	CCT	Delta uv
6 160 Lm	5 590 Lm	47 Lm/W	84 700 Cd	5 320 K	

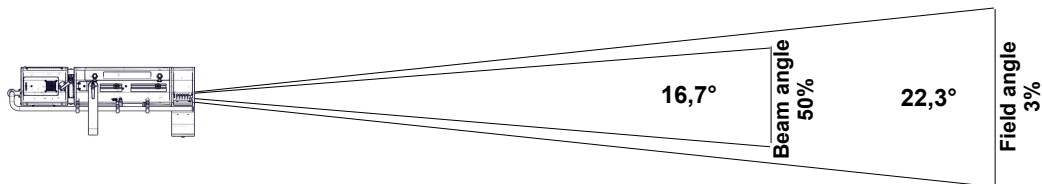

Distance	5 m	10 m	15 m	20 m	25 m	30 m
Field diameter	2 m	3,9 m	5,9 m	7,9 m	9,9 m	11,8 m
Illumination	3 400 lux	850 lux	380 lux	220 lux	140 lux	95 lux
Distance	15 ft	35 ft	50 ft	65 ft	80 ft	100 ft
Field diameter	5,9 ft	13,8 ft	19,7 ft	25,6 ft	31,5 ft	39,4 ft
Illumination	380 fc	70 fc	34 fc	21 fc	14 fc	9 fc

Light quality report

CCT	DeltaUV	CRI Ra	CRI R9	CQS Qa	TM30-18 Rf	TM30-18 Rg	TLCI	SSI [D5363]
5 370K	0.0004	95	66	93	92	102	90	72

CRI - CIE Colour Rendering Index

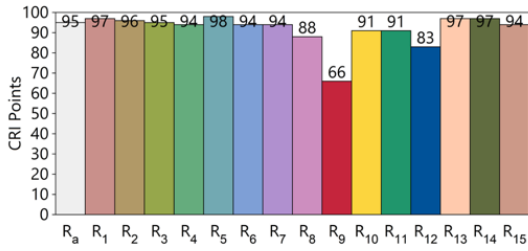

TLCI - Television Lighting Consistency Index

Test : CCT = D5365 (-0.5)
TLCI-2012 : 90 (D5365)

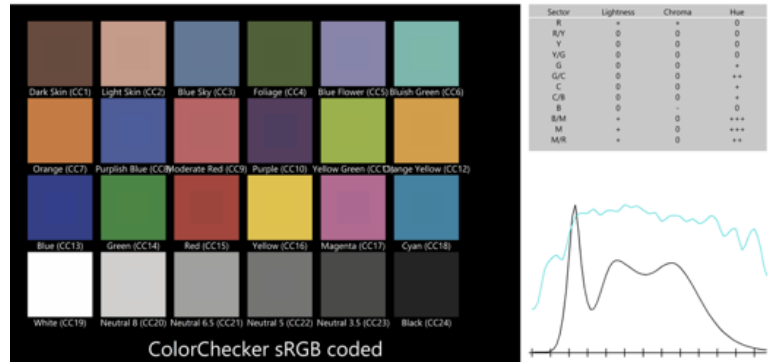

CQS - NIST Colour Quality Scale

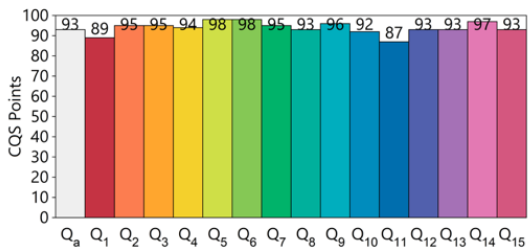

ANSI/IES TM-30-18 Colour Rendition Report

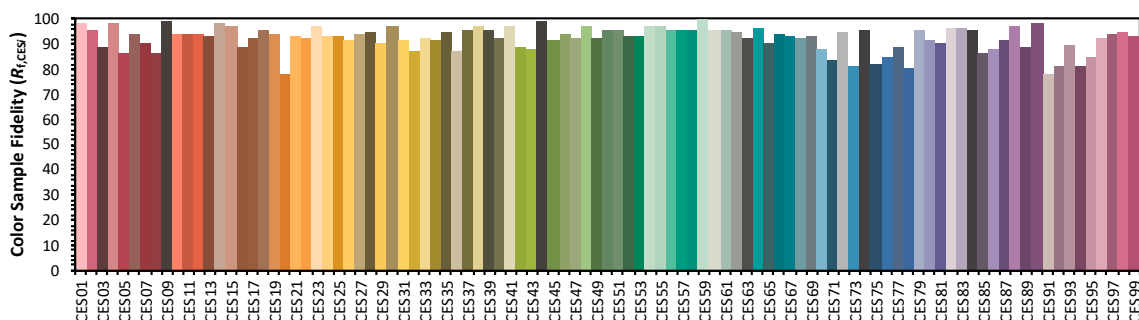
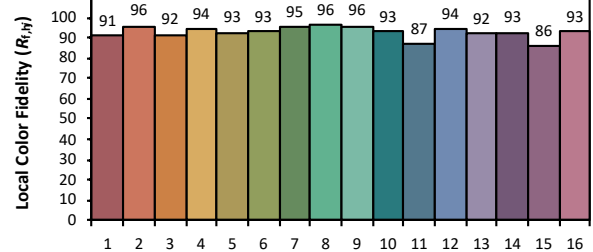
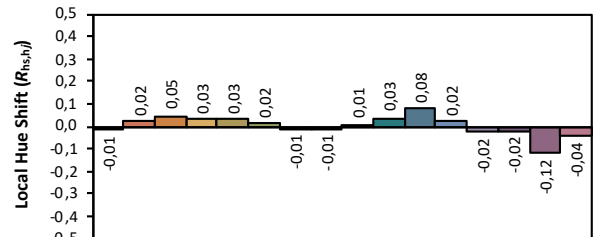
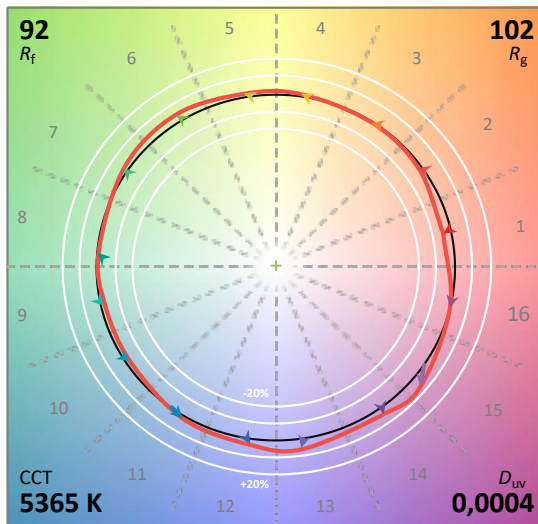
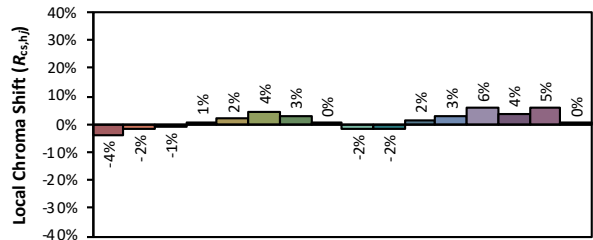
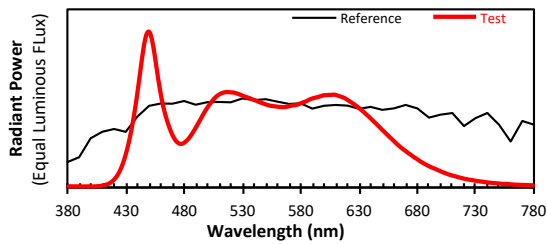

Colours are for visual orientation purposes only. Created with the IES TM-30-18 Calculator Version 2.00